

# **Examples to Support the Housing Health and Safety Rating System**

## **CONTENTS**

Introduction  
Help in using this CD-ROM  
Detailed list of worked examples  
Content of example sheets

## INTRODUCTION

These Worked Examples give Model answers for each of the 29 categories of potential housing hazards included in the Housing Health and Safety Rating System (HHSRS). They also include suggestions to improve the conditions and so reduce or remove the hazards described.

The aim of these Worked Examples is to encourage consistency of rating and to provide a training resource for local authorities and others. They are designed to complement the information in the *HHSRS Guidance (Version 2)*.

The order and numbering of the Worked Examples follows the grouping of the health and safety hazards used in the Guidance. For the more common or important hazards, more than one Worked Example is provided.

Note – The photographs and descriptions are illustrative and have been provided for these purposes only. The descriptions of the conditions found, while realistic, are fictional and do not represent the condition found in any of the properties shown.

Photographs used to illustrate the examples were provided by –  
Building Research Establishment,  
Stephen Battersby,  
Mel Cairns,  
Rachel Court,  
Rob Flynn,  
Stephen Lawrence,  
Richard Moore,  
David Ormandy and  
Jan Price.

## HELP IN USING THIS CD-ROM

The contents of this CD include the contents page; this introductory and help page; and a detailed list of the worked examples, showing the hazard category, age and type of dwelling and the HHSRS rating for each example. This is followed by three pages detailing the content of a typical worked example and the examples themselves, each of which comprise a front and back page.

### Navigation

There are three ways to navigate the contents:-

1. You can use the navigational tools provided in the *Acrobat Reader* menu bar to go to previous and next pages and to the first and last pages of the whole document.
2. You can use the bookmarks that are visible in the menu to the left of the page. These bookmarks provide the fullest navigation. Every page is listed – you can expand a section by clicking on the graphic icon to the left of the title and see the full list of examples within the section including links to the front and back page of each. Clicking on the icon again will contract the list. You can hide the bookmarks by clicking the appropriate button on the *Acrobat Reader* menu bar.
3. You can use the contents page – the top link in the bookmarks menu or the first page button in the *Acrobat Reader* menu bar. The active links are highlighted in green. The contents page only lists the main sections and sub-sections and not every example.

You can adjust the view of each page using the zoom tool or the three view buttons towards the right of the menu bar. The view settings for each page link in the bookmarks menu is 'fit width' except for the section heading links which go to a 'full page' view of the first page of the section.

### Printing

If you wish to print a section or an individual page you can do so in the normal way from the menu bar. The examples have been designed as front and back pages of a single sheet. If it is possible on your printer, we recommend using the duplex option to print both sides of an example on a single sheet.

### © Crown Copyright 2004

This publication, excluding any logos, may be reproduced free of charge in any format or medium for research, private study or for internal circulation within an organisation. This is subject too it being reproduced accurately and not used in a misleading context. The material must be acknowledged as Crown copyright and the title of the publication specified.

For any other use of this material, please write to:-  
HMSO Licensing  
St Clements House  
2-16 Colegate,  
Norwich NR3 1BQ  
Fax: 01603 723000  
or e-mail: [licensing@hmso.gov.uk](mailto:licensing@hmso.gov.uk).

Further copies of this CD-ROM are available from:

ODPM Publications  
PO Box 236  
Wetherby  
West Yorkshire  
LS23 7NB  
Tel: 0870 1226 236  
Fax: 0870 1226 237  
Textphone: 0870 120 7405  
E-mail: [odpm@twoten.press.net](mailto:odpm@twoten.press.net)

You may also access this document online via the Office of the Deputy Prime Minister's web site ( [www.odpm.gov.uk](http://www.odpm.gov.uk) )

September 2004

**LIST OF WORKED EXAMPLES**

<b>WE no.</b>	<b>HAZARD</b>	<b>Dwelling age</b>	<b>Dwelling type &amp; if non-self-contained (nsc)</b>	<b>HHSRS Rating</b>
<b>A – PHYSIOLOGICAL REQUIREMENTS</b>				
Hygrothermal Conditions				
1.1	Damp and mould growth	1946-79	Flat: purpose built	A
1.2	Damp and mould growth	Pre 1920	Flat: converted (nsc)	B
1.3	Damp and mould growth	1946-79	House: end terrace	B
1.4	Damp and mould growth	1920-45	House	H+
2.1	Excess cold	1946-79	Flat: purpose built	A
2.2	Excess cold	Pre 1920	Flat: converted	A
2.3	Excess cold	1946-79	House: semi-detached	A
2.4	Excess cold	Pre 1920	House: mid terrace	C
3.1	Excess heat	Pre 1920	Flat: converted (nsc)	C
Pollutants (non-microbial)				
4.1	Asbestos (& MMF)	1946-79	House: bungalow	C
4.2	Asbestos (& MMF)	1920-45	Flat: purpose built	B
5.1	Biocides	Pre 1920	Flat: converted	D
6.1	Carbon monoxide	Pre 1920	Flat: converted (nsc)	D -
6.2	Carbon monoxide	Pre 1920	House: terraced	C
6.3	Nitrogen Dioxide	Pre 1920	Flat: converted (nsc)	C
6.4	Sulphur Dioxide	Pre 1920	House: cottage	E
7.1	Lead	1920-45	House: semi-detached	C
8.1	Radiation	Pre 1920	House: farmhouse	A
8.2	Radiation	1920-45	House: semi-detached	B
8.3	Radiation	1946-79	House: mid-terrace	D
9.1	Un-combusted fuel gas	1920-45	House: semi-detached	B
10.1	Volatile organic compounds	Pre 1920	Flat: converted (nsc)	E
<b>B – PSYCHOLOGICAL REQUIREMENTS</b>				
Space, Security, Light & Noise				
11.1	Crowding and space	Pre 1920	House: mid-terrace	H- /E*
11.2	Crowding & space	Pre 1920	House: mid-terrace	H- /B-*
12.1	Entry by intruders	Pre 1920	Flat: converted (nsc)	C
13.1	Lighting	1946-79	House: detached	F
13.2	Lighting	Pre 1920	Flat: converted	A
14.1	Noise	Pre 1920	Flat: converted	B
14.2	Noise	Pre 1920	Flat: converted	D
<b>C – PROTECTION AGAINST INFECTION</b>				
Hygiene, Sanitation & Water				
15.1	Domestic hygiene/pests	1946-79	House: semi-detached	C
15.2	Domestic hygiene/refuse	1946-79	Flat: purpose-built	D
16.1	Food safety	Pre 1920	House: semi-detached	B +
16.2	Food safety	1946-79	Flat: purpose-built	D +
17.1	Personal hygiene	Pre 1920	Flat: converted (nsc)	B +
17.2	Personal hygiene/drainage	Pre 1920	Flat: converted	C
17.3	Personal hygiene/sanitation	Pre 1920	House: mid-terrace	D -
18.1	Water supply	1946-79	House: detached	C

\* Rating considering number of current occupants

Examples to Support the HHSRS V2 – March 2004

WE no.	HAZARD	Dwelling age	Dwelling type & if non-self-contained (nsc)	HHSRS Rating
<b>D – PROTECTION AGAINST ACCIDENTS</b>				
Falls				
19.1	Falls assoc. with baths etc	1920-45	House: semi-detached	D
20.1	Falls on the level	Pre 1920	House: almshouse	B
20.2	Falls on the level	Pre 1920	House: mid-terrace	D
20.3	Falls on the level	Post 1979	House: end-terrace	E
20.4	Falls on the level	1946-79	House: semi-detached	B -
21.1	Falls on stairs and steps	1920-45	House: semi-detached	B
21.2	Falls on stairs and steps	Pre 1920	House: cottage	A
21.3	Falls on stairs and steps	Pre 1920	House: mid-terrace	E
21.4	Falls on stairs and steps	Post 1979	House: cluster	E-
22.1	Falls between levels	1946-79	House: detached	D -
22.2	Falls between levels	Pre 1920	House: semi-detached	D
22.3	Falls between levels	Pre 1920	Flat: converted	F
22.4	Falls between levels	1920-45	House: semi-detached	J
Electric Shocks, Fires, Burns & Scalds				
23.1	Electrical hazards	1920-45	House: semi-detached	B
23.2	Electrical hazards	1946-79	House: end-terrace	E
24.1	Fire	Pre 1920	Flat: converted (nsc)	B
24.2	Fire	Pre 1920	Flat: converted (nsc)	C
24.3	Fire	1920-45	House: detached	D
24.4	Fire	Post 1979	House: cluster	F -
25.1	Hot surfaces & materials	Pre 1920	House: semi-detached	C
25.2	Hot surfaces & materials	1920-45	Flat: purpose built	D
25.3	Hot surfaces & materials	1920-45	House: semi-detached	E -
Collisions, Cuts and Strains				
26.1	Collision and entrapment	Pre 1920	House: almshouse	E
26.2	Collision and entrapment	Pre 1920	Flat: purpose-built	E
27.1	Explosions	1920-45	House: semi-detached	B
28.1	Poor ergonomics	Pre 1920	Flat: converted (nsc)	G -
29.1	Structural collapse etc	1920-45	House: semi-detached	B
29.2	Structural collapse etc	Pre 1920	Flat: converted (nsc)	E

# LAYOUT AND CONTENT OF TYPICAL WORKED EXAMPLE

## PAGE 1 - DESCRIPTIONS

### Category of Hazard

Vulnerable age group for hazard

Other potential hazards associated with same deficiency(ies)

Photographs & figures of deficiency(ies) relating to hazard category

Dwelling age and type

Short description of deficiency(ies) in order of importance (A,B,C etc)

Matters affecting the likelihood of a hazardous occurrence and assessed degree of contribution for each deficiency (A,B,C etc)

### FALLS ON STAIRS ETC

HHSRS VERSION 2

Vulnerable group	Persons aged 60 years or over	Multiple locations	Yes	No
Related hazards	None	Secondary hazards	Yes	No

**A) Front door steps**



**A/B) Plan**

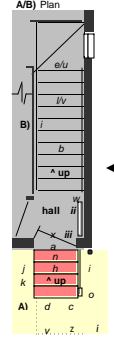

**B) Main stairs**



**C) Steps at gate**



**DESCRIPTION OF HAZARD/S**  
Dwelling: 1930s, Semi-detached house

**A) Frontdoorsteps:** These are of smooth painted concrete and have no top 'landing'. The bottom riser is high and uneven (300mm max). There is a wobbly tubular steel handrail on one side but no guarding at all, despite the narrow width. There is no external porch light and little street lighting.

**B) Mainstair:** The main internal stairs have two winders at the top and are moderately steep. There is a handrail only along the outside wall of the straight flight. There is a projecting radiator in the small hall and some glass in the front door at the foot of the stairs.

**C) Steps at gate:** These steps close to the front gate are of rough spalling concrete. They have high uneven risers and a narrow tread. There is a crude rotten timber handrail but no guarding.

LIST OF RELEVANT MATTERS					
LIKELIHOOD	A	B	C	OUTCOMES	A B C
a Tread lengths	1	1	2	a Length of flight	- 1 -
b Riser heights	3	1	2	b Pitch of stairs	- 2 -
c Variation in T&Rs	3	1	2	c Projections etc #	- 2 3
d Nosing length	-	-	-	d Hard surfaces #	2 1 2
e Poor friction quality	3	-	1	e Construction/repair	2 - 3
f Openings - in stairs	-	-	-	f Thermal efficiency	3 - 2
g Alternating treads	-	-	-	<b># Secondary hazards</b>	
h Lack/height handrail	3	2	2	i Concrete kerb	2 - -
j Lack/height guarding	3	-	1	j Projecting radiator	- 2 -
m Stair width	2	-	-	k Glass in front door	- 1 -
n Length of flight	-	-	-	<b>Key</b> 3 Seriously defective 2 Defective 1 Not satisfactory - Satisfactory/NA	
o-q Inadequate lighting	3	-	3		
r Door/s onto stairs	-	-	-		
s Inadequate landing	3	-	-		
t Construction/repair	2	-	3		
u Thermal efficiency	2	-	1		

Version of HHSRS

Whether deficiencies at more than one location

Whether secondary hazards present

Plan of relevant part/s of showing location of defective and non-satisfactory matters listed below (if appropriate)

Other photographs/figures of main hazard/s (A,B,C etc) and/or of secondary hazards

Matters affecting the health outcomes and contribution for each deficiency (A,B,C)

Note of secondary hazards, if present

Key to severity of matters

## PAGE 2 - ASSESSMENTS

Assessment of likelihood showing Model answer (in Red) and Average scores (with Green line)

Assessment of outcomes showing Model answer (in Red) and Average scores (with Green line)

Rating band for Model answer (in Red) relative to Average (Green line)

Likelihood and spread of harms after improvement

Rating band after improvement (in Yellow) relative to Average

### HEALTH AND SAFETY RATING SYSTEM SCORES

1920-45 House

LIKELIHOOD Low → High

1 in 18

Average: 226

Example 18



**Justification** The main stairs are assessed as giving the same likelihood of a major fall as the average for inter-war houses, (i.e. around 1 in 230), the limited handrail provision cancelling out any benefits of the broad winders. However, the added presence of the front access steps - particularly dangerous in icy weather and at night - substantially increases the overall annual probability of such a fall - to between 1 in 24 and 1 in 13.

OUTCOMES	Average	Example	%
Class I	2.1	4.6	4.6
Class II	7.4	10	10.0
Class III	20.5	25	21.5
Class IV	70.1	63.9	63.9

**Justification** The stairs are designed to be carpeted but the resulting lower harms are offset by the small hall, projecting radiator and single glazing in the door, albeit this is not at low level. However, the presence of the external front door steps and steps near the front gate, both flanked by rough tarmac and a concrete kerb, significantly increase the risk of a fatal or severe fall occurring, particularly in cold weather or at night.

**Example** Average: 155

RATING A B C D E F G H I J Score: 3504

**RATING SCORES AFTER IMPROVEMENT**

IMPROVE Likelihood to 1 in 180 Outcomes to 2.2 | ### | ### %

**Justification** Replacing the steps to the front door and at the gate with steps satisfying current Building Regulations and British Standards and fitting porch light and a full handrail on both sides of the main stair would give a more average likelihood of a major fall and an average spread of health outcomes, and thereby a more average rating.

NEW RATING A B C D E F G H I J Score: 217

Av Nos: Average likelihood, outcomes and HHSRS score for falls on stairs and steps by persons aged 60 years or more in and around 1920-45 houses, 1997-99.

Age and type of dwelling

Model answer on likelihood

Justification for Model answer on likelihood of an occurrence

Model answer on spread of health outcomes

Justification for Model answer on spread of a health outcomes

Resulting Model hazard score

Justification for Model score after improvement

Score after improvement

Basis of averages





### The Average and Model HHSRS Rating

Using the Representative Scale Points for the chosen Likelihood and Outcomes ranges (red figures above), the HHSRS score (eg, 3504) is calculated using the prescribed formula. In which of the ten Rating Bands this score falls is shown in on the rating scale. This is the Model HHSRS Rating for the particular Worked Example. For comparison, the average Rating for all dwellings of the same type and age is also given (calculated from the average Likelihood and Outcomes - ie, those shown in green). Where this falls on the rating scale is also shown (with a green line) and

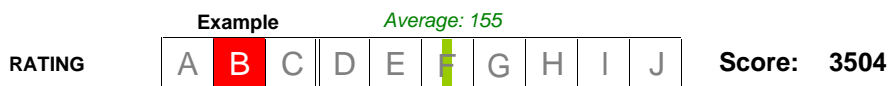

### Rating Scores after Improvement

Each Worked Example concludes by repeating the scoring procedure for the assessment of the condition following the suggested works to deal with the hazard. Again the Model scores for the likelihood and outcomes are given but in an

**IMPROVE**      Likelihood to    1 in   180      Outcomes to    2.2 | 10.0 | 21.5 | 66.3    %

After the justification for these scores, the new HHSRS score and rating is illustrated in a similar format as before. The final score (e.g. 217) is provided and the equivalent rating band shown (in Yellow) on the rating band. Again, the average rating for all dwellings of the same type and age, is provided where possible.

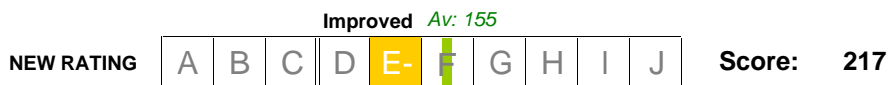

**NB** - For the Hazard of Crowding and Space, which is related to a mis-match between the household size and the dwelling, the Worked Example concludes by repeating the HHSRS scoring after considering the number

### Basis of Averages

For each Worked Example, the basis of the averages used is given at the bottom of the back page. The averages given are normally for the same type of dwelling (house or flat) and age of dwelling (pre 1920, 1920-45, 1946-79 or post 1979) as that being assessed. Where the sample of occurrences is too small to provide an accurate spread of harms for particular dwelling types and ages, the averages given relate to all dwellings of that type, or, where samples are particularly small, to all dwellings.

### Layout and Content of Typical Example

The following page shows the content and layout of a typical Worked Example.

# DAMP AND MOULD GROWTH

HHSRS VERSION 2

<b>Vulnerable age</b>	Persons aged under 15 years	<b>Multiple locations</b>	<b>Yes</b>	No
<b>Related hazards</b>	Excessive cold	<b>Secondary hazards</b>	Yes	<b>No</b>

**A) Front end bedroom**



**B) Bathroom**



**DESCRIPTION OF HAZARDS**

**Dwelling:** 1960s, 2/3rd floor 3 bedroom end maisonette

**Background:** The 4 storey block is of brick crosswall and exposed concrete floor slab construction. Space heating to each maisonette is by means of a gas-fired ducted warm air system.

- A) Front bedroom:** The concrete floor to the top floor front bedroom and bathroom projects over the access balcony by approximately 1 metre. There is damp affected plaster and mould growth to the front main walls and to the exterior flank wall to the front bedroom.
- B) Bathroom:** The front wall of the bathroom and adjacent ceiling and internal walls are affected by severe and extensive mould growth, caused mainly by condensation resulting from cold bridging.

**LIST OF RELEVANT MATTERS**

**LIKELIHOOD & OUTCOMES**

	<b>A</b>	<b>B</b>		<b>A</b>	<b>B</b>
1 Rising damp	-	-	l Plumbing/waste pipes	-	-
2 Penetrating damp	-	-	j Rain water goods	-	-
3 Condensation	3	3	k Roof/sub-floor spaces	-	-
4 Mould growth	3	3	l Small room sizes	-	-
a Energy efficiency	3	3			
b Background ventilation	-	-	<b># Secondary hazards</b>	<b>A</b>	<b>B</b>
c Extract ventilation	-	3	- None	-	-
d Clothes drying facilities	-	-			
e Damp proofing	-	-	<b>Key</b>	3 Seriously defective	
f Disrepair	-	-		2 Defective	
g Exposed water tanks etc	-	-		1 Not satisfactory	
h Water using appliances	-	-		- Satisfactory/NA	

**HEALTH AND SAFETY RATING SYSTEM SCORES**

1946-79 purpose-built Flat

LIKELIHOOD Low → High

1 in 1

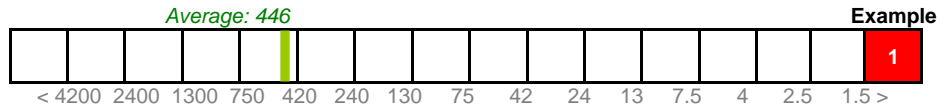

**Justification** The presence of such severe mould growth in the bathroom and, to a lesser extent, in the smallest of the three bedrooms, means that the risk of causing or exacerbating asthma and other respiratory illnesses due to the inhalation of spores becomes extremely likely over a 12 month period. Such a severe outbreak is also likely to have a psychological effect on any occupant.

OUTCOMES Low → High

%

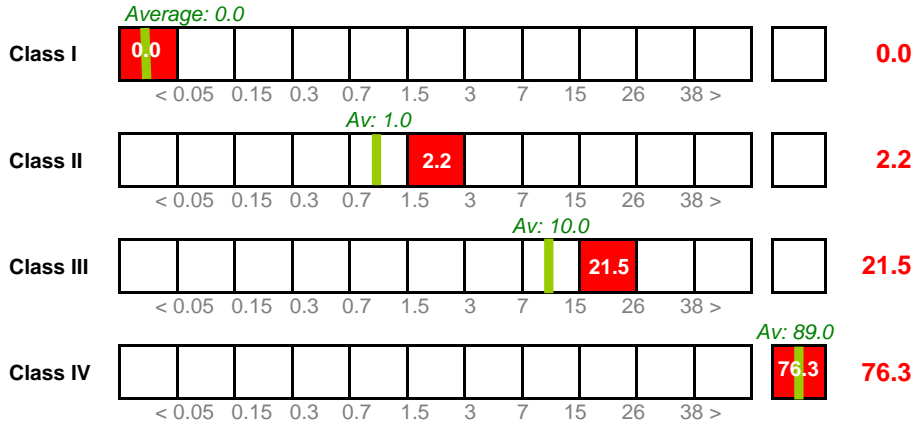

**Justification** The risk of a severe or serious outcome occurring is increased by the severity of the mould growth in the bathroom and in the smallest of the three bedrooms, this being most likely to be occupied by a child. The output of spores will be significantly above the level given by the damp and occasional slight mould found in more average situations. The psychological effect may be a further contributing factor causing harm.

Example

Average: 11

RATING



Score: 9413

**RATING SCORES AFTER IMPROVEMENT**

IMPROVE Likelihood to 1 in 560 Outcomes to 0 | 1.0 | 10.0 | 89.0 %

**Justification** The problems in the dwelling are mainly due to the cold bridges created by the exposed ends and ceiling of the reinforced concrete slab forming the top floor to the block. Installing insulated cladding and a better heating system would reduce the risk to better than average levels.

Average: 11 Improved

NEW RATING



Score: 8

Av: Nos Average likelihood, outcomes and HHSRS score for hazards from damp & mould by persons aged under 15 years in 1946-79 non-HMO, 1997-99.

# DAMP AND MOULD GROWTH

HHSRS VERSION 2

<b>Vulnerable age</b>	Persons aged under 15 years	<b>Multiple locations</b>	<b>Yes</b>	No
<b>Related hazards</b>	Excessive cold	<b>Secondary hazards</b>	Yes	<b>No</b>

Rear elevation



A) Door to patio



B) Dormer to top floor rear room



C) Ceiling and walls to rear room



**Dwelling** : Top floor flat in a Victorian terraced house (HMO).

## DESCRIPTION OF HAZARD/S

**Background:** The house generally is in a poor state of repair. The top floor flat is on two levels, the upper floor being the attic. There is access from the lower floor onto a patio - the flat roof of the back addition.

**A) Rear main wall:** The wall is severely affected by dampness. The roof allows water to soak downwards, and the eavesgutters leak soaking the outside of the wall and allowing water to bounce up from the "patio". The plaster is perished and there is mould growth spreading from the floor.

**B&C Rear attic room:** There are slipped slates and ill fitting flashings around the dormer opening. Damp has penetrated soaking the ceiling and walls to the rear attic room.

## LIST OF RELEVANT MATTERS

LIKELIHOOD & OUTCOMES	A	B&C		A	B&C
1 Rising damp	-	-	l Plumbing/waste pipes	-	-
2 Penetrating damp	3	3	j Rain water goods	3	-
3 Condensation			k Roof/sub-floor spaces	-	-
4 Mould growth	2		l Small room sizes	-	-
a Energy efficiency	3	3			
b Background ventilation	-	-	<b># Secondary hazards</b>	<b>A</b>	<b>B&amp;C</b>
c Extract ventilation			None	-	-
d Clothes drying facilities	-	-			
e Damp proofing	-	-	<b>Key</b>	3	Seriously defective
f Disrepair	3	3		2	Defective
g Exposed water tanks etc	-	-		1	Not satisfactory
h Water using appliances	-	-		-	Satisfactory/NA

**HEALTH AND SAFETY RATING SYSTEM SCORES**

Pre 1920 non s.c. Flat

LIKELIHOOD Low → High

1 in 2

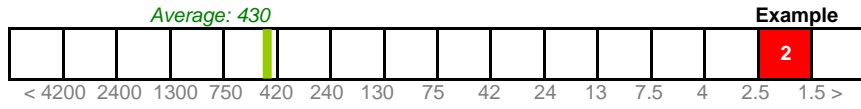

**Justification** The presence of such severe dampness and the mould growth means there is a very high likelihood of a harmful occurrence over the next twelve months. The condition would also have a psychological effect on any occupant.

**OUTCOMES**

%

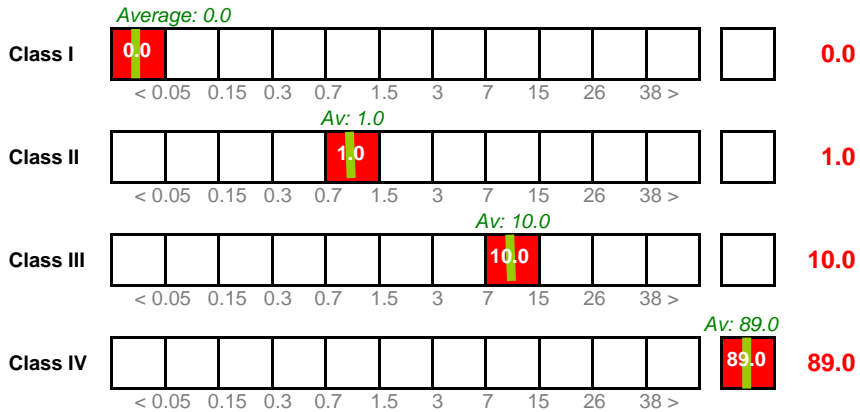

**Justification** Although there is some mould growth, it is not that serious. The over-riding problem is the dampness, and there is nothing to suggest the outcomes would differ from the average.



**RATING SCORES AFTER IMPROVEMENT**

IMPROVE Likelihood to 1 in 320 Outcomes to 0 | 1.0 | 10.0 | 89.0 %

**Justification** The minimum works would be to strip and properly recover the whole of roof; to renew the rainwater goods; and remove all damp affected plaster and replaster and redecorate the walls. This would reduce the likelihood to near the average for the age of the property. (Clearly, other works are required to the premises as a whole.)



Av: Nos Average likelihood, outcomes and HHSRS score for hazards from damp & mould by persons aged under 15 years in pre 1920 HMOs and all dwellings, 1997-99.



# DAMP AND MOULD GROWTH

HHSRS VERSION 2

**Vulnerable age** Persons aged under 15 years      **Multiple locations** Yes      No  
**Related hazards** Excessive Cold      **Secondary hazards** Yes      No

A) Living room



C) Second bedroom



B) Kitchen



Rear elevation



Front elevation



**DESCRIPTION OF HAZARD/S**

**Dwelling:**

1960's end-terrace, 2 bedroomed house

**Background:** This is a two storey, two-bedroomed end of terrace house built in the late 1960s of non-traditional construction on an exposed estate designed to Radburn principles.

- A) **Living room:** Rising and some penetrating damp with associated mould growth is affecting the external gable wall in both recesses to either side of the fireplace in the living room.
- B) **Kitchen:** Dampness caused mainly by condensation is affecting the whole of the front external wall surrounding the window and adjacent ceiling and party wall in the small kitchen.
- C) **Second bedroom:** Penetrating damp and some associated mould is affecting the end wall.

There is hair-line cracking to the external render generally.

**LIST OF RELEVANT MATTERS**

LIKELIHOOD & OUTCOMES		A	B	C		A	B	C	
1	Rising damp	3	-	-	l	Plumbing/waste pipes	-	-	-
2	Penetrating damp	2	-	2	j	Rain water goods	-	-	-
3	Condensation	2	3	2	k	Roof/sub-floor spaces	-	-	-
4	Mould growth	2	1	2	l	Small room sizes	-	-	-
a	Energy efficiency	2	2	2					
b	Background ventilation	-	3	-	#	Secondary hazards	A	B	C
c	Extract ventilation	-	3	-	-	None	-	-	-
d	Clothes drying facilities	-	-	-					
e	Damp proofing	3	-	-	Key	3	Seriously defective		
f	Disrepair (walls)	2	-	2		2	Defective		
g	Exposed water tanks etc	-	-	-		1	Not satisfactory		
h	Water using appliances	-	-	-		-	Satisfactory/NA		







**HEALTH AND SAFETY RATING SYSTEM SCORES**

1920-45 House

LIKELIHOOD Low → High

1 in 100

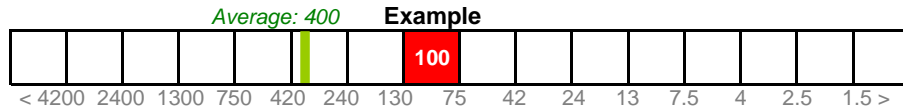

**Justification**

Although representing a serious problem of rising damp, the damp is confined to the living room. The house is also reasonably well heated, having gas fired central heating, and is well ventilated. There is no associated mould growth. Consequently, although inconvenient and unsightly, the risk to health is relatively small. Nevertheless, the likelihood is higher than average, most housing having no serious problems of damp in the living room or elsewhere.

**OUTCOMES**

%

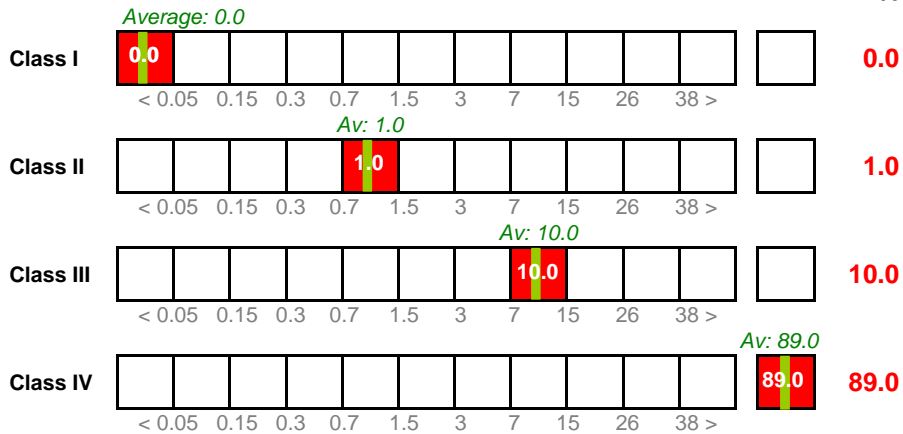

**Justification**

As there is no associated mould growth, the outcomes are no worse than average. However, notwithstanding the average outcomes, the high likelihood gives a HHSRS score above average and a rating band of H plus.



**RATING SCORES AFTER IMPROVEMENT**

IMPROVE Likelihood to 1 in 5,600 Outcomes to 0.0 | 1.0 | 10.0 | 89.0 %

**Justification**

Lowering the garden path alongside the side wall to below the three layers of staffordshire blue bricks is likely to reduce the amount of rising damp considerably. However, to cure the problem completely, the cavity needs to be cleaned out and the DPC restored. Curing the dampness totally would reduce the rating to better than the average for the national stock.



*Av: Nos* Average likelihood, outcomes and HHSRS score for hazards from damp & mould by persons aged under 15 years in 1920-45 non-HMO and all dwellings, 1997-99.

# EXCESS COLD

HHSRS VERSION 2

<b>Vulnerable group</b>	Persons aged 60 years or over	<b>Multiple locations</b>	<b>Yes</b>	<b>No</b>
<b>Related hazards</b>	Damp and Mould Growth	<b>Secondary hazards</b>	<b>Yes</b>	<b>No</b>

East facing elevation of block



## DESCRIPTION OF HAZARDS

**Dwelling:** End maisonette, on 5th and 6th floors of 1960s nine storey slab block of 32 maisonettes, built of non-traditional concrete construction; orientation East/West.

Elevation of maisonette



**Background:** The dwelling consists of a living room, kitchen and store on the lower floor and two bedrooms and combined bathroom on the upper floor.

- A) Heating:** Heating is by electric elements set in the floor slab of the lower floor, with a thermostat control in the living room. The occupier supplements this with portable electric heaters.
- B) Windows and walls:** The windows are single glazed and metal framed. All the windows are centre pivot opening lights, except the bathroom which is a top hung opening light. There is damp and mould growth to the external walls to the upper floor rooms.

## LIST OF RELEVANT MATTERS

LIKELIHOOD & OUTCOMES	A	B	# Secondary hazards	A	B
a) Thermal insulation	-	2	- None	-	-
b) Dampness	-	2			
c) Settling of insulation	-	-			
d) Type of heating provision	3	-			
e) Size of heating system	3	-			
f) Installation & maintenance	3	-			
g) Controls to heating system	3	-			
h) Amount of ventilation	-	3	<b>Key</b>	3	Seriously defective
i) Ventilation controls	-	3		2	Defective
j) Disrepair to ventilation	-	-		1	Not satisfactory
k) Draughts/excess ventilation	-	3		-	Satisfactory/NA



# EXCESS COLD

HHSRS VERSION 2

<b>Vulnerable group</b>	Persons aged 60 years or over	<b>Multiple locations</b>	<b>Yes</b>	No
<b>Related hazards</b>	Damp and Mould Growth	<b>Secondary hazards</b>	Yes	<b>No</b>

A) Rear windows



A) Window to kitchen



A) Window to w.c.



B) Living room fire



A) w.c. window - interior



## DESCRIPTION OF HAZARDS

**Dwelling:** Converted flat in 1900's end terraced house

**Background:** This large three-storey Victorian house was converted in the 1950's to provide three self-contained flats, one on each floor. The top floor flat comprises a large living room at the front and a bedroom at the rear of the main part of the house. The bathroom, a separate w.c. and the kitchen/diner are located in the long back addition. The loft has 100 mm of insulation.

- A) Windows:** Windows to the back addition kitchen, bathroom and w.c. compartment have been replaced with louvred windows. All other windows are single glazed, double hung sashes.
- B) Heating:** The open fireplaces throughout the flat have been sealed. Radiant bar heaters fitted in the front living/dining room, rear bedroom and in the dining area in the back addition.

## LIST OF RELEVANT MATTERS

LIKELIHOOD & OUTCOMES	A	# Secondary hazards	A
a) Thermal insulation	2	- None	-
b) Dampness	-		
c) Settling of insulation	3		
d) Type of heating provision	3		
e) Size of heating system	2		
f) Installation & maintenance	-		
g) Controls to heating system	-		
h) Amount of ventilation	3	<b>Key</b>	3 Seriously defective
i) Ventilation controls	3		2 Defective
j) Disrepair to ventilation	-		1 Not satisfactory
k) Draughts/excess ventilation	3		- Satisfactory/NA



# EXCESS COLD

HHSRS VERSION 2

<b>Vulnerable group</b>	Persons aged 60 years or over	<b>Multiple locations</b>	Yes	No
<b>Related hazards</b>	Damp and Mould Growth	<b>Secondary hazards</b>	Yes	No

Front elevation



Hot water tank

## DESCRIPTION OF HAZARDS

**Dwelling:** 1950s non-traditional semi-detached house, similar to the BISF design.

**Background:** The walls are of steel frame construction, faced externally with vertical steel sheeting. Internally the walls are finished with plasterboard supported on timber frames.

**A) Heating:** This was originally by open fires throughout. At sometime, the open fireplaces to the first floor were sealed and gas fires fitted to the two ground floor living rooms. The occupier uses portable electric heaters to supplement the gas fires.

**B) Insulation:** The original construction included glasswool quilting hung within the external wall frame, and a thin (50mm) layer to the whole of the roof space. There is no insulation to the hot water tank and the windows are single glazed.

## LIST OF RELEVANT MATTERS

LIKELIHOOD & OUTCOMES	A	B	# Secondary hazards	A	B
a) Thermal insulation	-	3	- None	-	-
b) Dampness	-	-			
c) Settling of insulation	-	3			
d) Type of heating provision	2	-			
e) Size of heating system	3	-			
f) Installation & maintenance	3	-			
g) Controls to heating system	3	-			
h) Amount of ventilation	-	-	<b>Key</b>	3 Seriously defective	
i) Ventilation controls	-	-		2 Defective	
j) Disrepair to ventilation	-	-		1 Not satisfactory	
k) Draughts/excess ventilation	-	-		- Satisfactory/NA	



**HEALTH AND SAFETY RATING SYSTEM SCORES**

1945-79 House

LIKELIHOOD Low → High

1 in 32

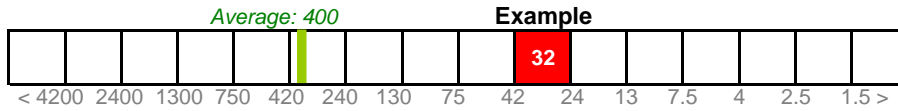

**Justification** The two gas fires are not capable of heating the whole of the dwelling. The insulation, even as original, would be considered inadequate now, and has settled over the years to become less effective. The result is that the likelihood of the dwelling being unhealthily cold is increased.

**OUTCOMES**

%

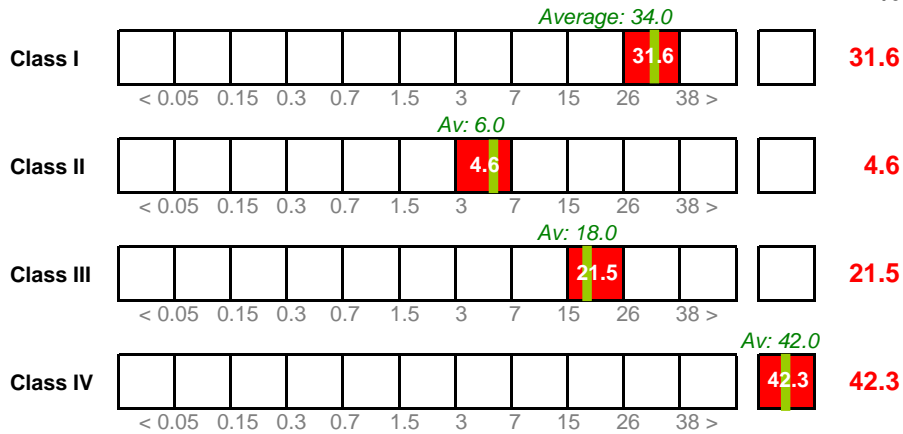

**Justification** Although the likelihood of a harmful occurrence is much higher than average, there is nothing to indicate that spread of harms will vary from the average.

Example Average: 880

RATING



Score 10233

**RATING SCORES AFTER IMPROVEMENT**

IMPROVE Likelihood to 1 in 1,000 Outcomes to 31.6 | 4.6 | 21.5 | 42.3 %

**Justification** Installing an efficient heating system capable of heating the whole of the dwelling and providing additional thermal insulation to the external walls and the roof space would reduce the rating around the average for dwellings of this age group (Band D). Installing double glazing would further reduce the likelihood to band E.

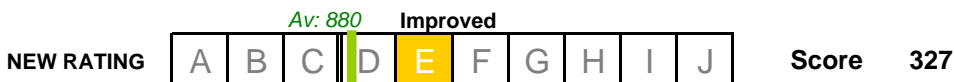

Av: Nos Average likelihood, outcomes and HHSRS score for excessive cold for persons aged 60 years or more in 1964-1979 Non-HMOs and all dwellings, 1997-99.

# EXCESS COLD

HHSRS VERSION 2

<b>Vulnerable group</b>	Persons aged 60 years or over	<b>Multiple locations</b>	Yes	No
<b>Related hazards</b>	None	<b>Secondary hazards</b>	Yes	No



Loft space



Loft space



Gas-fired boiler



Front elevation



Rear elevation

## DESCRIPTION OF HAZARDS

**Dwelling:** 3 bedrooomed  
 pre 1920 House

**Background:** This two storey mid-terraced late Victorian house still has three bedrooms, the original large front bedroom having been partitioned when one of the rear bedrooms was converted to a bathroom some 35 years ago. At the same time, a single storey kitchen extension was built in cavity brick and this and the original 9inch rear wall was rendered. The front wall is some 14 inch thick and comprises a stone outer facing and a brick inner leaf.

**Heating and insulation:** Around 15 years ago, full central heating was installed in the dwelling run from a gas-fired boiler located against the boundary wall in the kitchen extension. The windows, which are mainly sash, are in good condition but single glazed. However, the roof space (where some of the sarking is torn) lacks any form of thermal insulation above the thick lath and plaster ceilings.



## LIST OF RELEVANT MATTERS

LIKELIHOOD & OUTCOMES	A	# Secondary hazards	A
a) Thermal insulation	3	- None	-
b) Dampness	-		
c) Settling of insulation	-		
d) Type of heating provision	-		
e) Size of heating system	-		
f) Installation & maintenance	-		
g) Controls to heating system	-		
h) Amount of ventilation	-		
i) Ventilation controls	-		
j) Disrepair to ventilation	-		
k) Draughts/excess ventilation	-		

<b>Key</b>	3	Seriously defective
	2	Defective
	1	Not satisfactory
	-	Satisfactory/NA

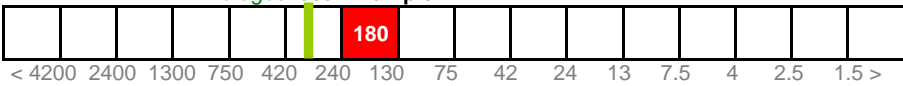
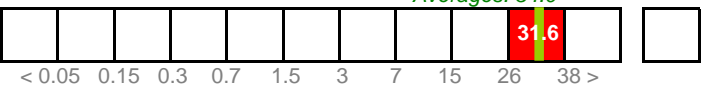
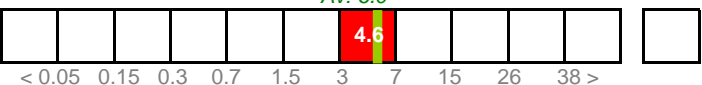
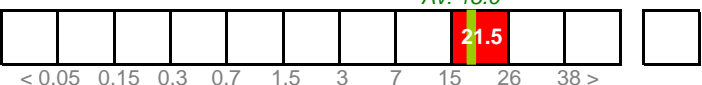
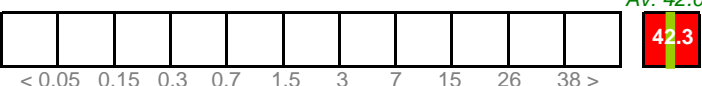

<b>HEALTH AND SAFETY RATING SYSTEM SCORES</b>		Pre 1920 House
<b>LIKELIHOOD</b> Low → High	<b>1 in 180</b>	
<div style="display: flex; justify-content: space-between; align-items: center;"> <span style="color: green;">Averages: 330</span> <span><b>Example</b></span> </div> 		
<b>Justification</b>	Although some 15 years old, the heating system and its associated controls are reasonably efficient. The heat loss from the walls is also lower than for many dwellings of this age, due to their extra thickness, the rendering of the solid walls, and the cavity walled extension, but particularly due to the fact that it is a mid-terraced dwelling. However, overall the likelihood is judged higher than average by the single glazing and the total lack of loft insulation.	
<b>OUTCOMES</b>	<b>%</b>	
<b>Class I</b>	<div style="display: flex; justify-content: space-between; align-items: center;"> <span style="color: green;">Averages: 34.0</span> </div> 	<b>31.6</b>
<b>Class II</b>	<div style="display: flex; justify-content: space-between; align-items: center;"> <span style="color: green;">Av: 6.0</span> </div> 	<b>4.6</b>
<b>Class III</b>	<div style="display: flex; justify-content: space-between; align-items: center;"> <span style="color: green;">Av: 18.0</span> </div> 	<b>21.5</b>
<b>Class IV</b>	<div style="display: flex; justify-content: space-between; align-items: center;"> <span style="color: green;">Av: 42.0</span> </div> 	<b>42.3</b>
<b>Justification</b>	Although the risk of unhealthy cold indoor temperatures and the consequent risk of harm is slightly higher than average, the spread of harms is not increased in terms of its severity.	
<div style="display: flex; justify-content: center; align-items: center;"> <span style="color: green;">Example Average: 1066</span> </div>		
<b>RATING</b>		<b>Score 1819</b>
<b>RATING SCORES AFTER IMPROVEMENT</b>		
<b>IMPROVE</b>	Likelihood to <b>1 in 1,800</b> Outcomes to <b>31.6   4.6   21.5   42.3 %</b>	
<b>Justification</b>	Installing 250mm of loft insulation and replacing the windows throughout with double glazed units would increase the energy efficiency of the house significantly. This would reduce the likelihood of excessive cold to better than average.	
<b>NEW RATING</b>	<div style="display: flex; justify-content: center; align-items: center;"> <span style="color: green;">Av: 1066</span> <span style="margin-left: 20px;"><b>Improved</b></span> </div> 	<b>Score 181</b>
<span style="color: green;">Av Nos:</span> Average likelihood, outcomes and HHSRS score for excessive cold for persons aged 60 years or more in pre 1920 houses, 1997-99.		



# EXCESS HEAT

HHSRS VERSION 2

<b>Vulnerable group</b>	Persons aged 60 years or over	<b>Multiple locations</b>	Yes	No
<b>Related hazards</b>	Excess cold; Falls from windows.	<b>Secondary hazards</b>	Yes	No

Front elevation



Rear roof light

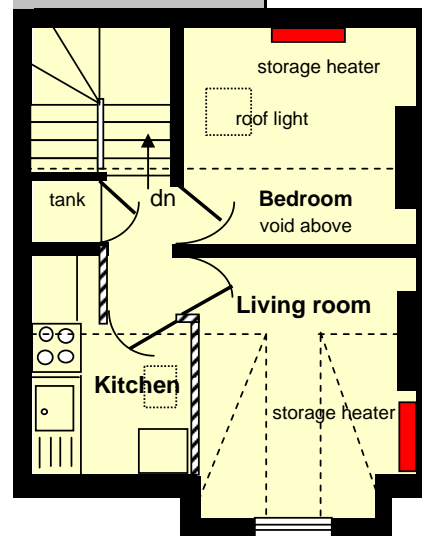

## DESCRIPTION OF HAZARDS

Plan of flat

**Dwelling:** Pre 1920 non-self contained attic flat

**Background:** This three-storey late Victorian house in Inner London was converted in the 1950s to provide a self contained flat on the ground floor and three non-self contained flats on the upper floors. The one bedroomed attic flat shares a bathroom and a separate w.c. on the first floor with the two flats on that level, but has its own small kitchen.

**Insulation:** Apart from 100mm of compacted insulation in the small, shallow void at the apex, the attic flat has no thermal insulation, being located directly under the slate roof.

**Ventilation:** The full height living room window faces north and has one low opening casement. The bedroom has a small openable roof light, while the kitchen is lit by fixed transparent tiles and ventilated by a small extractor above the electric cooker that discharges into the roof void.

**Heating:-** The flat is heated by two old storage heaters, running on off-peak electricity, situated under the ceiling eaves in the living room and bedroom.

## LIST OF RELEVANT MATTERS

### LIKELIHOOD & OUTCOMES

	A
a Thermal insulation	3
b Orientation of glazing	1
b External shading & exposure	-
c Heating controls	2
d Ventilation provision	3
e Ventilation control	-
f Disrepair to ventilation	-

### # Secondary hazards

None

Key			A
3	Seriously defective	1	Not satisfactory
2	Defective	-	Satisfactory/NA

**HEALTH AND SAFETY RATING SYSTEM SCORES**

Pre 1920 non s.c. flat

**LIKELIHOOD** Low → High

**1 in 180**

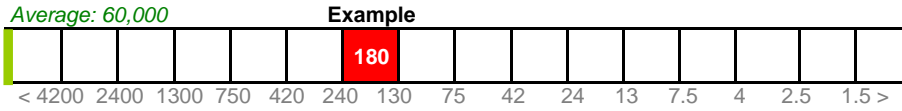

**Justification** The lack of roof insulation and limited provision for ventilation, results in above average indoor temperatures in all rooms in hot weather. Fortunately, the living room window faces north (but presents a risk of falls if fully opened due to its low positioned opening light). Conversely, the rooms quickly become cold at night, even in late Spring and early Autumn, but using the old storage heaters to combat this results in further excess heat in the flat when the next day is warm.

**OUTCOMES** Low → High

**%**

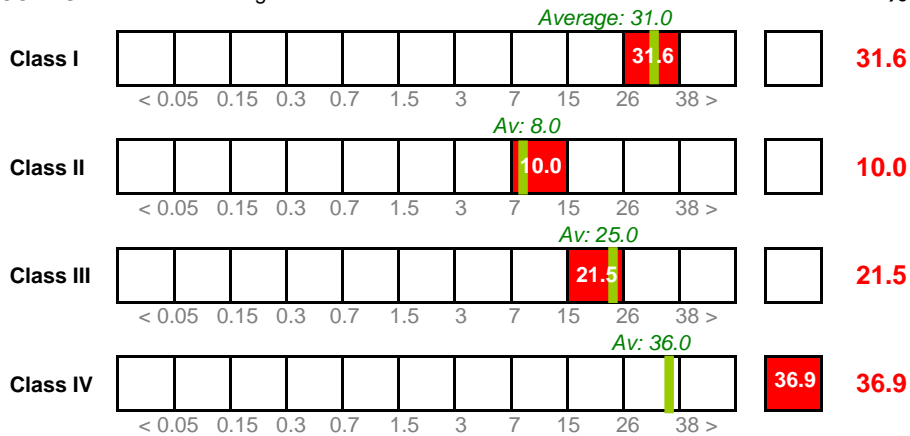

**Justification** Although the risk of the dwelling reaching unhealthily high temperatures and the consequent likelihood of harm is greater than average, there is nothing to suggest that the spread of harms would be other than average.



**RATING SCORES AFTER IMPROVEMENT**

**IMPROVE** Likelihood to **1 in 5,600** Outcomes to **31.6 | 10 | 21.5 | 36.9 %**

**Justification** There should be adequate thermal insulation to the roof and larger opening double glazed roof lights installed in the bedroom and kitchen. Other works required include replacing the extractor fan in the kitchen and the old storage heaters with modern more efficient and controllable units. This would increase the energy efficiency of the flat substantially and thereby reduce the likelihood of both excessive heat and cold.

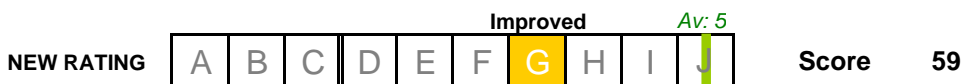

*Av Nos:* Average likelihood, outcomes and HHSRS score for excessive cold for persons aged 60 years or more in pre 1920 HMOs, 1997-99.

# ASBESTOS

HHSRS VERSION 2

**Vulnerable group** All persons  
**Related hazards** None

**Multiple locations** Yes No  
**Secondary hazards** Yes No

A) Base of External wall



A) Front door



A) Fibres on ground



## DESCRIPTION OF HAZARDS

**Dwelling:** 1950s pre-fabricated bungalow.

- A) **External walls:** There is evidence that the asbestos sheet insulation to the pre-fabricated wall panels is breaking down. Where the base of the wall panels has broken or is missing, fibrous material has accumulated on the ground. This has occurred at several places on the ground and paths around the base of the house, including positions close to the front door. No hazard warnings are present.

## LIST OF RELEVANT MATTERS

LIKELIHOOD & OUTCOMES	A	# Secondary hazards	A
a Date of construction	3	- None	
b Presence of asbestos	3		
c Unsealed asbestos	3		
d Unlabelled asbestos	3		
e Disrepair - damage	3		
f Presence of MMF	-		
		<b>Key</b>	3 Seriously defective
			2 Defective
			1 Not satisfactory
			- Satisfactory/NA

**HEALTH AND SAFETY RATING SYSTEM SCORES**

1946-79 Bungalow

LIKELIHOOD Low → High

1 in 180

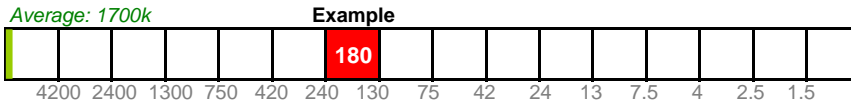

**Justification** The extent of the breakdown of the asbestos insulation sheets and the accumulation of fibres on the ground close to the front door means that the likelihood of a hazardous event occurring within a 12 month period is relatively high, particularly if one includes the psychological effects caused by the fear of asbestos in and around the home. However, the problem is confined to outside of the dwelling where the fibres are widely dispersed by the air, producing a substantially smaller risk than the same problem indoors.

**OUTCOMES**

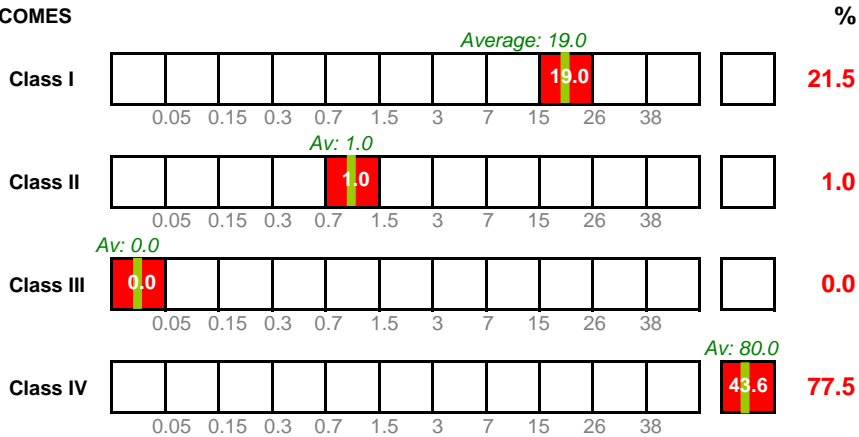

**Justification** The spread of possible health outcomes resulting from inhaling asbestos fibres in relatively small quantities is likely to remain the same regardless of the increased likelihood of such an event occurring.



**RATING SCORES AFTER IMPROVEMENT**

IMPROVE Likelihood to 1 in 5,600 Outcomes to 21.5 | 1.0 | 0.0 | 77.5 %

**Justification** The asbestos sheets have deteriorated too badly to be sealed and their careful removal, under controlled conditions, is required to eliminate the health and safety risk. Once cleansed of any residual fibres resulting from the removal, the likelihood would reduce to that for a minimum exposure background level.



Av: Nos Average likelihood, outcomes and HHSRS score for risk from asbestos for all persons in 1946-79 dwellings, 1997-99.

# ASBESTOS (and MMF)

HHSRS VERSION 2

**Vulnerable group** All persons  
**Related hazards** Fire

**Multiple locations** Yes **No**  
**Secondary hazards** Yes **No**

Damaged asbestos sheet around lock .



Front elevation



Close up of break showing original fixing



## DESCRIPTION OF HAZARDS

**Dwelling:** 1920-45 top floor 2 bedroomed Flat

**Background:** This is a four storey, 'walk-up' block of mansion flats built in the 1930s. The mainly two bedroomed flats on the top floor of the block were upgraded for fire proofing in the early 1960s.

**Doors:** As part of the upgrading, the wooden front doors to each flat were lined internally with 8mm 'chrysotile' (white) asbestos cement sheeting. In the flat under consideration, some of the sheeting has broken away around the point where it has been shaped to accommodate the door locks. This has resulted in some fraying and the exposure of the asbestos fibres. Above and below the locks, a cover strip running around the sides of the door, designed to protect the edge of the asbestos sheeting, is also missing.

## LIST OF RELEVANT MATTERS

LIKELIHOOD & OUTCOMES	A	# Secondary hazards	A
a Date of construction	x	- None	
b Presence of asbestos	3		
c Unsealed asbestos	3		
d Unlabelled asbestos	3	<b>Key</b>	3 Seriously defective
e Disrepair - damage	3		2 Defective
f Presence of MMF	-		1 Not satisfactory
			- Satisfactory/NA
			x Applicable



**HEALTH AND SAFETY RATING SYSTEM SCORES**

1920-45 purpose-built Flat

LIKELIHOOD Low → High

1 in 56

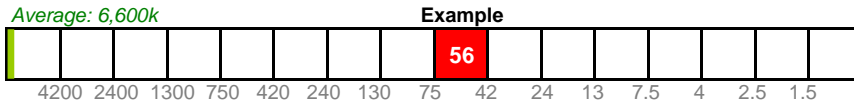

**Justification** The damage to the asbestos sheet and the consequent exposure of fibres and its position in the small hall at the only entrance to the particular flat, means that the likelihood of a hazardous occurrence is significantly increased. This is particularly so if the psychological effects caused by the fear of having asbestos in the home is included in the assessment. Currently, the amount of frayed material is limited but, due to its vulnerable location, the amount of damage and flaking of material is likely to increase over the next 12 months.

**OUTCOMES**

%

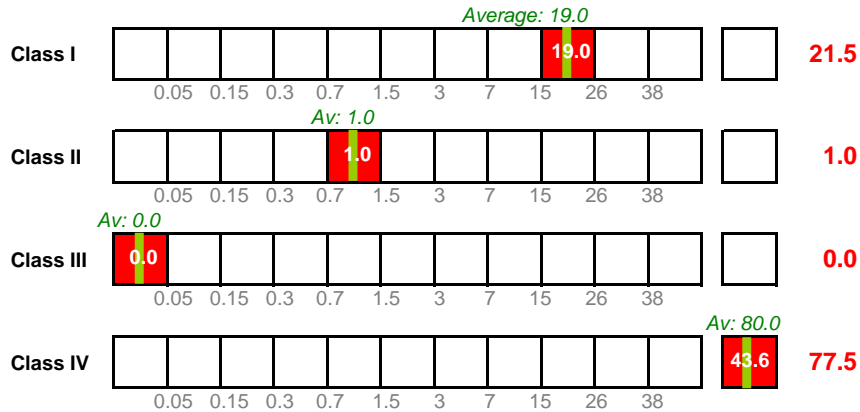

**Justification** The spread of possible health outcomes resulting from inhaling asbestos fibres is likely to remain the same regardless of the increased likelihood of such an event occurring.



**RATING SCORES AFTER IMPROVEMENT**

IMPROVE Likelihood to 1 in 5,600 Outcomes to 21.5 | 1.0 | 0.0 | 77.5 %

**Justification** The asbestos sheets have been damaged too badly to be sealed and their careful removal, under controlled conditions, is required to eliminate the health and safety risk. Once cleansed of any residual fibres resulting from the removal, the likelihood would reduce to that for the minimum exposure background level. For fire safety, the front door to the flat also needs to be replaced with a modern fire doors satisfying current regulations.



Av: Nos Average likelihood, outcomes and HHSRS score for risk from asbestos for all persons in 1920-45 dwellings, 1997-99.



# BIOCIDES

HHSRS VERSION 2

**Vulnerable group** All ages  
**Related hazards** VOCs

**Multiple locations** Yes No  
**Secondary hazards** Yes No

Front elevation of flat



Rear elevation of flat



Front of block during conversion



Rear of block during conversion



## DESCRIPTION OF HAZARDS

**Dwelling:** First floor flat in 1900 detached house.

**A) Insecticide:** This is a conversion of a former HMO into three self-contained dwellings. During the conversion works, woodworm infestation to first floor landing was discovered. On further investigation, it was clear that there was a live woodworm infestation affecting timber to the whole of the first floor and to most of the ground to first floor staircase. All the timber to the first floor and the staircase was stripped out and renewed with timber treated with insecticide to prevent re-infestation. The remaining timber to the dwelling, including the ground floor floor, the first floor ceiling and the roof timbers were thoroughly treated. Following the timber treatment, the windows in the treated rooms were left open for only a limited period, being subject to the presence of the builders and reasonable weather conditions. However, within a week of the completion of the conversion, less than two months after the completion of the timber treatment, all the flats were occupied.

## LIST OF RELEVANT MATTERS



**LIKELIHOOD & OUTCOMES**  
 a Use of biocides  
 b Misuse - re. Instructions etc

**A**  
 3  
 3

**# Secondary hazards**  
 - None

**A**  
 -

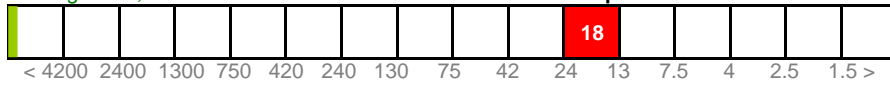
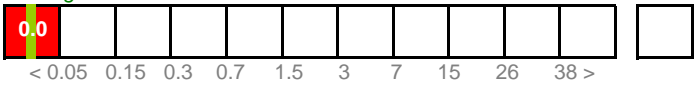
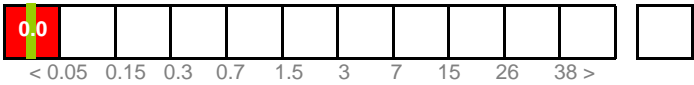
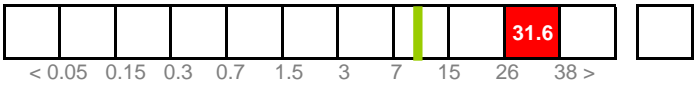
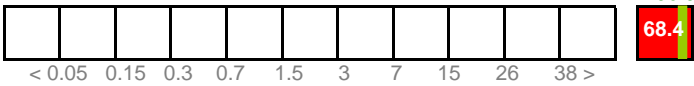
**Key**  
 3 Seriously defective  
 2 Defective  
 1 Not satisfactory  
 - Satisfactory/NA

<b>HEALTH AND SAFETY RATING SYSTEM SCORES</b>		Pre 1920 Non s.c. Flat
<b>LIKELIHOOD</b>	Low → High	<b>1 in 18</b>
<div style="display: flex; justify-content: space-between;"> <span style="color: green;">Average: 513,333</span> <span>Example</span> </div> 		
<b>Justification</b>	All the new timber and all the remaining old timber have been treated with biocides. Until fumes have fully dispersed, the occupants of each flat will be at risk, particularly those in the first floor flats. Although the fumes emitted are likely to reduce to safe levels after two to three months, until then, the occupants are exposed to dangerous levels.	
<b>OUTCOMES</b>		%
<div style="display: flex; justify-content: space-between;"> <span style="color: green;">Average: 0.0</span> </div>		
Class I		<b>0.0</b>
Class II		<b>0.0</b>
Class III	<div style="display: flex; justify-content: space-between;"> <span style="color: green;">Av: 9.1</span> </div> 	<b>31.6</b>
Class IV	<div style="display: flex; justify-content: space-between;"> <span style="color: green;">Av: 90.9</span> </div> 	<b>68.4</b>
<b>Justification</b>	As all rooms have been treated, including bedrooms, occupants cannot escape the fumes, and the likelihood of harm is increased by the prolonged exposure.	
<div style="display: flex; justify-content: space-between;"> <span>Example</span> <span style="color: green;">Average: &lt;1</span> </div>		
<b>RATING</b>		<b>Score 564</b>
<b>RATING SCORES AFTER IMPROVEMENT</b>		
<b>IMPROVE</b>	Likelihood to <span style="color: red;">1 in 5,600</span> Outcomes to <span style="color: red;">0   0   10.0   90.0 %</span>	
<b>Justification</b>	The occupants should be rehoused temporarily and each dwelling thoroughly ventilated before the occupants move back. To have reduced the likelihood of the hazard occurring, the use of any biocide should have been limited or, if possible, avoided. Where used, all treated areas should have been well ventilated. New timber need not have been treated.	
<b>NEW RATING</b>	<div style="display: flex; justify-content: space-between;"> <span>Improved</span> </div> 	<b>Score: &lt;1</b>
<span style="color: green;">Av: Nos</span> Average likelihood, outcomes and HHSRS score for biocides for all persons in pre 1920 HMOs.		

# CARBON MONOXIDE

HHSRS VERSION 2

<b>Vulnerable age</b>	All ages	<b>Multiple locations</b>	Yes	<b>No</b>
<b>Related hazards</b>	Fire, Nitrogen Dioxide, Explosion	<b>Secondary hazards</b>	Yes	<b>No</b>

A) Gas instantaneous water heater

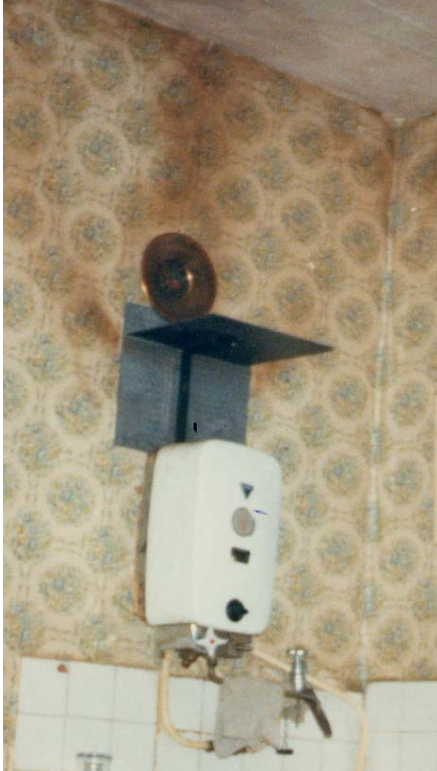

A) Location in kitchen/diner



## DESCRIPTION OF HAZARDS

**Dwelling:** Non-self contained flat in 1890's house

**Background:** This hazard is in a three-storey, Victorian terraced house, converted into four non self contained flats and heated by old electric convector heaters. There are two shared bathrooms, one with a w.c., and a second separate w.c.

- A) Water heater:** The photographs are of the 1st floor rear kitchen/diner, which connects directly with the bedroom, and show the sink with a gas instantaneous water heater over and the adjacent gas cooker. A crude metal plate and horizontal cowel have been fixed on the wall above the unflued water heater but this has not prevented the wall and ceiling above becoming stained by the hot gasses emitted. The window is a double hung sash and there is no other means of ventilation. There are no carbon monoxide detectors in the dwelling.

## LIST OF RELEVANT MATTERS

LIKELIHOOD & OUTCOMES	A	# Secondary hazard	A
1 Open flued appliances	-	- None	-
a Flueless appliances	3		
b Disrepair to appliance	3		
c Inadequate ventilation	2		
d Disrepair to ventilation	-		
e State of flues	-		
f Disrepair to flues	-		
g Flue outlet siting	-	<b>Key</b>	3 Seriously defective
h Extractor fans	-		2 Defective
i Ventilation lobby	-		1 Not satisfactory
j CO Detectors	3		- Satisfactory/NA

**HEALTH AND SAFETY RATING SYSTEM SCORES**

Pre 1920 Non s.c. Flat

LIKELIHOOD Low → High

1 in 18

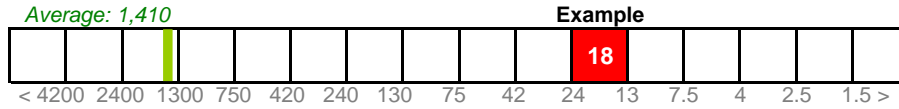

**Justification**

From the extent of the staining of the walls and ceiling and its pattern around the metal cowl and decorative plate, this unflued water heater is clearly emitting a substantial volume of hot and potentially dangerous gases. With no permanent fixed ventilation, the build up of carbon monoxide and other toxic gases in the room and adjacent bedroom from both the gas cooker and water heater is likely to be considerable. Consequently, the likelihood of the occupants suffering some harm will be high.

**OUTCOMES**

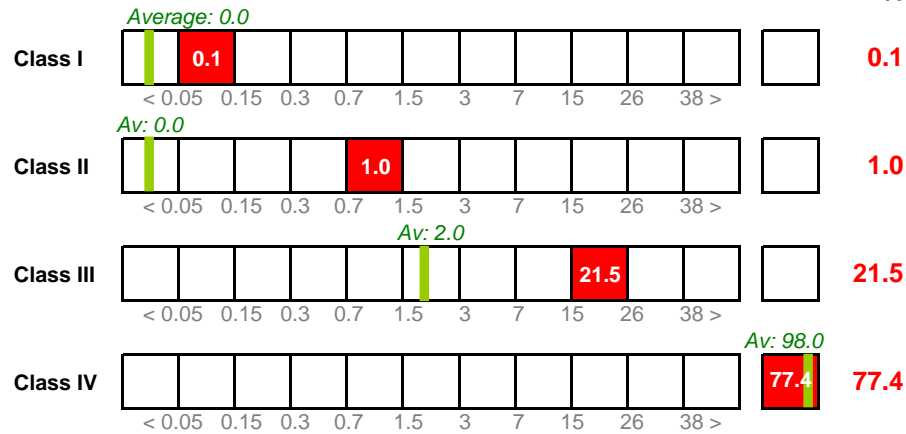

**Justification**

The build up of carbon monoxide and other toxic gases in the room and adjacent bedroom increases significantly the risk of a fatal, severe or serious outcome. Together with the high likelihood, this gives a score of 512, a hazard rating of Band D-.



**RATING SCORES AFTER IMPROVEMENT**

IMPROVE Likelihood to 1 in 1,800 Outcomes to 0.0 | 0.0 | 2.2 | 97.8 %

**Justification**

Replacing the gas heater with a modern appliance with a balanced flue conforming to the relevant Gas Safety (Installation and Use) Regulations would reduce the likelihood and spread of outcomes to average for the type and age of dwelling, but not below due to the remaining gas cooker. This would lower the rating to Band J.



Av (Nos): Average likelihood, outcomes and HHSRS score for carbon monoxide poisoning for all persons in pre 1920 HMOs.

# CARBON MONOXIDE

HHSRS VERSION 2

**Vulnerable group** All ages  
**Related hazards** Fire, Nitrogen Dioxide etc

**Multiple locations** Yes  
**Secondary hazards** Yes No

A) Living room window



A) Gas fire in living room



B) Plan of living room and conservatory

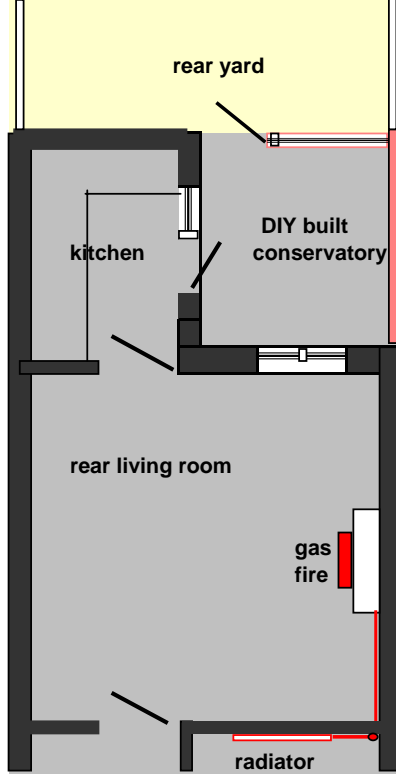

## DESCRIPTION OF HAZARDS

**Dwelling:** c. 1900 two-storey terraced house

- A) Gas fire:** The sole source of heating in the principal rear living room is by a fixed gas fire, which has a back boiler serving radiators in three other rooms. The central radiant has burnt through and the fire burns with a reddish flame. (The cooker in the kitchen is electric)
- B) DIY built Conservatory:** The part of the rear yard alongside the back addition has been enclosed, with a corrugated plastic roof and timber studding supporting single fixed glazing. There is no direct ventilation to the rear ground floor living room and the only opening light in the casement window is at high level, the bottom two and one of the upper opening lights having been sealed up. The only external opening to the conservatory is the door.

## LIST OF RELEVANT MATTERS

LIKELIHOOD & OUTCOMES	A	# Secondary hazards	A
1 Open flued appliances	3	- None	-
a Flueless appliances	-		
b Disrepair to appliance	3		
c Inadequate ventilation	3		
d Disrepair to ventilation	1		
e State of flues	3		
f Disrepair to flues	-		
g Flue outlet siting	-		
h Extractor fans	0		
i Ventilation lobby	-		
j CO Detectors	3		
		<b>Key</b>	3 Seriously defective
			2 Defective
			1 Not satisfactory
			- Satisfactory/NA

**HEALTH AND SAFETY RATING SYSTEM SCORES**

Pre 1920 House

LIKELIHOOD Low → High

1 in 6

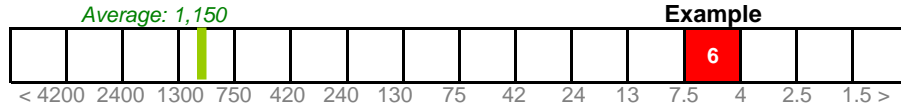

**Justification** There is no provision for permanent ventilation to the back boiler in the rear room and the gas fire shows signs of incomplete combustion. In practice, although the DIY conservatory is not particularly air tight, the rate of air change is likely to fall well below currently recommended standards when the windows and kitchen and conservatory doors are closed. Consequently, with the incomplete combustion, the risk is much higher than average.

**OUTCOMES**

%

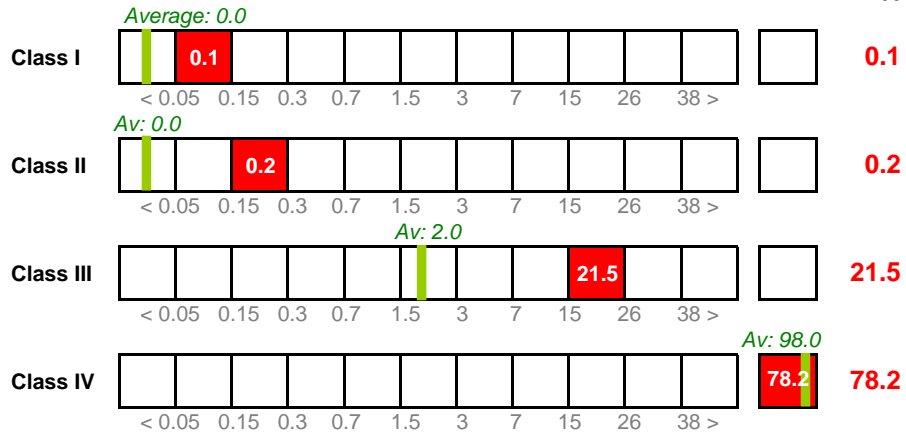

**Justification** The evidence of incomplete combustion indicates that there is likely be elevated levels of carbon monoxide and other gases in the rear room after the fire has been on for prolonged periods of time. This will increase the risk of fatal, severe and serious outcomes from these gases and, with the high likelihood, would give a high score of 1,405 and a hazard rating of C.



**RATING SCORES AFTER IMPROVEMENT**

**IMPROVE** Likelihood to 1 in 1,800 Outcomes to 0.0 | 0.0 | 2.2 | 97.8 %

**Justification** Providing permanent ventilation to the back boiler and gas fire and repairing the installation such that the appliance satisfied the relevant Gas Safety (Installation and Use) Regulations would reduce the likelihood and health outcomes to average or below. This would reduce the rating to Band J.



Av: Nos Average likelihood, outcomes and HHSRS score for carbon monoxide poisoning for all persons in pre 1920 non-HMO dwellings.



# NITROGEN DIOXIDE

HHSRS VERSION 2

<b>Vulnerable age</b>	All ages	<b>Multiple locations</b>	Yes	<b>No</b>
<b>Related hazards</b>	Carbon Monoxide, Fire	<b>Secondary hazards</b>	Yes	<b>No</b>

A) Cooker to first floor front right, bed-sitting room



Front elevation



Rear elevation



## DESCRIPTION OF HAZARDS

**Dwelling:** Non-self contained flat in 1900's converted house (HMO)

**Background:** This is the rear first floor bed-sit in a four storey mid terraced house (including attic and basement) that has been converted into four non-self contained units. The house is located in an inner city area where there are many similar HMOs. Entry to the flat is from a common staircase and landing. There is a shared bathroom on the first floor.

**Gas Cooker:** The gas cooker to the first floor rear bed-sitting room is situated in the rear corner of the room and together with an adjacent small sink and one kitchen unit constitutes the kitchen amenities for the accommodation. The cooker which has a high level grill is old and burns with a reddish flame. The only means of ventilation to the room is the openable double hung sash window. There is no permanent ventilation.

## LIST OF RELEVANT MATTERS

Pre 1920 non s.c. flat

LIKELIHOOD & OUTCOMES	A	# Secondary hazards	A
1 Open flued appliances	-	- None	-
a Flueless appliances	3		
b Disrepair to appliance	3		
c Inadequate ventilation	3		
d Disrepair to ventilation	-		
e State of flues	-		
f Disrepair to flues	-		
g Flue outlet siting	-	<b>Key</b>	3 Seriously defective
h Extractor fans	3		2 Defective
i Ventilation lobby	-		1 Not satisfactory
j CO Detectors	2		- Satisfactory/NA

### HEALTH AND SAFETY RATING SYSTEM SCORES

LIKELIHOOD Low → High

1 in 3

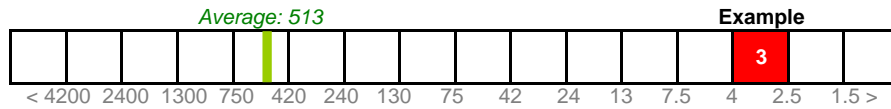

**Justification** The gas cooker provides the only means of cooking for the bed-sit, and is in fairly regular use (as is apparent from the stained adjacent walls). In use, combustion products spill into the room and, without permanent means of ventilation, Oxides of Nitrogen accumulate in the room, particularly in winter when the only window is kept permanently closed. As the room is used for both living and sleeping, there is no escape from the effects of these products.

**OUTCOMES**

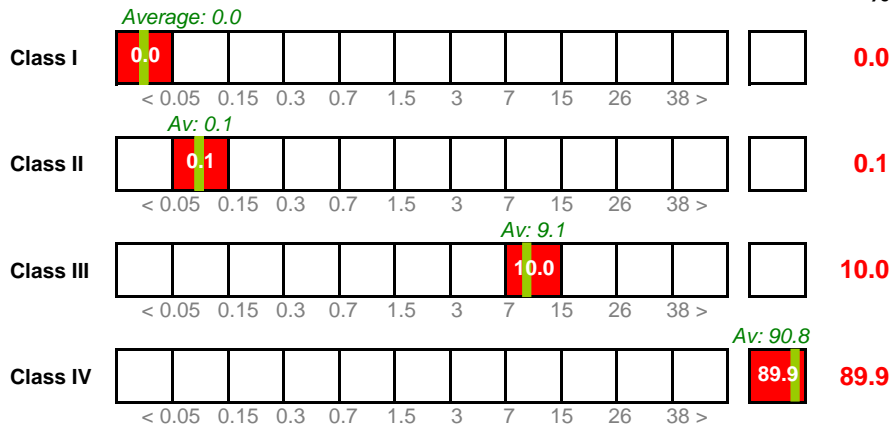

**Justification** There is nothing to indicate that the outcomes would be other than the average. However, with the high likelihood this still gives an HHSRS score of 1333 and a Band C rating.



### RATING SCORES AFTER IMPROVEMENT

**IMPROVE** Likelihood to 1 in 560 Outcomes to 0.0 | 0.1 | 10.0 | 89.9 %

**Justification** At the least, the gas cooker should be replaced with an electric cooker, and an extractor fan fitted to improve ventilation. Ideally, however, a kitchen should be relocated in a separate room which should be provided with permanent means of ventilation. This latter option would reduce the risk to average or better.



Av: Nos Average likelihood, outcomes and HHSRS score for oxides of nitrogen for all persons in pre 1920 houses in multiple occupation (HMOs).



# SULPHUR DIOXIDE

HHSRS VERSION 2

<b>Vulnerable age</b>	All ages	<b>Multiple locations</b>	Yes	<b>No</b>
<b>Related hazards</b>	Carbon Monoxide, Nitrogen Dioxide	<b>Secondary hazards</b>	Yes	<b>No</b>

**A) Solid fuel stove to side extension**



Front elevation



Rear elevation



**DESCRIPTION OF HAZARDS**

**Dwelling:** 19th century, stone cottage.

**Background:** This 19th century stone cottage has had some modernisation, but many of the existing features, including the old cast iron kitchen stove, have been kept.

**A) Solid fuel boiler:** The solid fuel boiler provides space heating for the side extension and hot water for domestic purposes. The dwelling is in an exposed rural area. When windy, smoke and fumes from the flue are blown back into the room. A new door and window make the kitchen relatively air tight and there is no permanent ventilation to the room.

**LIST OF RELEVANT MATTERS**

LIKELIHOOD & OUTCOMES	A	# Secondary hazards	A
1 Open flued appliances	2	- None	-
a Flueless appliances	-		
b Disrepair to appliance	-		
c Inadequate ventilation	3		
d Disrepair to ventilation	-		
e State of flues	-		
f Disrepair to flues	-		
g Flue outlet : siting	2	<b>Key</b>	3 Seriously defective
h Extractor fans	-		2 Defective
i Ventilation lobby	-		1 Not satisfactory
j Carbon monoxide detectors	-		- Satisfactory/NA

**HEALTH AND SAFETY RATING SYSTEM SCORES**

Pre 1920 House

LIKELIHOOD Low → High

1 in 10

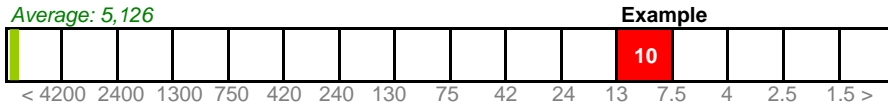

**Justification** Because of the exposed position of the dwelling, the likelihood of sulphur dioxide fumes and smoke being blown back into the room over the next twelve months is significantly greater than the average.

**OUTCOMES**

%

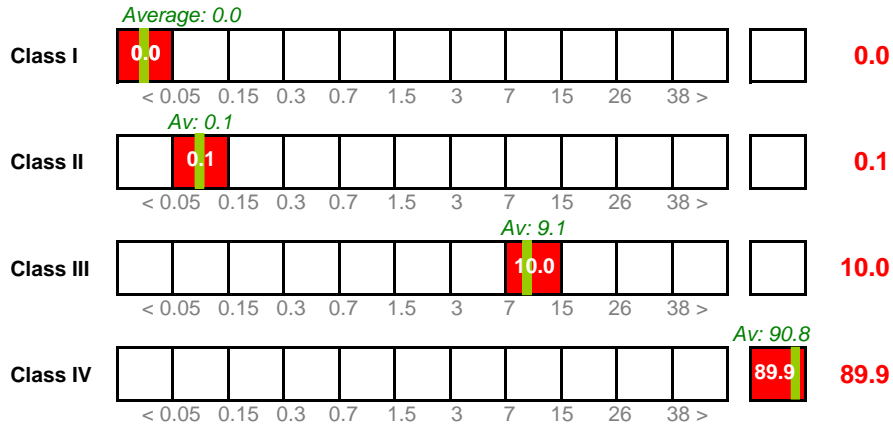

**Justification** Although the likelihood of an occurrence increases, there is nothing to suggest the average outcomes would change



**RATING SCORES AFTER IMPROVEMENT**

IMPROVE Likelihood to 1 in 320 Outcomes to 0.0 | 0.1 | 10.0 | 89.9 %

**Justification** The chimney height could be extended, but a better solution might be to provide a patent cowl to minimise the chances of fumes being blown back into the room. Permanent means of ventilation should also be installed. This should reduce the likelihood and consequent risk to better than average.



Av: Nos Average likelihood, outcomes and HHSRS score for sulphur dioxide poisoning for all pre 1920 houses.

# LEAD

HHSRS VERSION 2

**Vulnerable age** Persons aged under 3 years  
**Related hazards** None  
**Multiple locations** Yes  
**Secondary hazards** Yes No

Rear kitchen



Front elevation



Rear elevation



## DESCRIPTION OF HAZARDS

**Dwelling:** 1920s semi-detached house

- A) Lead paint:** There have been a few improvements and alterations to the house. However, repainting of internal woodwork has not included removal of the original paint and the main lead water supply pipe has not been changed. Much of the internal decoration is worn and peeling, the paint to internal woodwork is chipped in parts and repainting is needed.
- B) Lead pipes:** The water supply pipe serves the cold water tap over the sink and the electric water heater. The dwelling is in a rural area, and water supplies are known to be plumbo-solvent.

## LIST OF RELEVANT MATTERS

LIKELIHOOD & OUTCOMES	A	B	# Secondary hazards	A	B
a Date of construction	x	x	- None	-	-
b Old paintwork	3	-			
c Disrepair to old paint	1	-			
d Previous lead paintwork	-	-			
e Lead pipework	-	3			
f Plumbo-solvent water	-	2			
			<b>Key</b>	3	Seriously defective
				2	Defective
				1	Not satisfactory
				-	Satisfactory/NA
				x	Applicable

**HEALTH AND SAFETY RATING SYSTEM SCORES**

1920-45 House

LIKELIHOOD Low → High

1 in 6

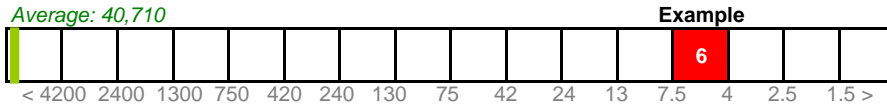

**Justification** The internal woodwork is in need of repainting, which, in view of its condition, would involve removal of the old paint down to the bare wood. Without appropriate precautions being taken, this could release old lead-based paint dust and fumes into the dwelling. This combined with the contamination of the water supply would dramatically increase the likelihood of an occurrence. (Without the old paint, the likelihood would be around 1 in 56.)

**OUTCOMES**

%

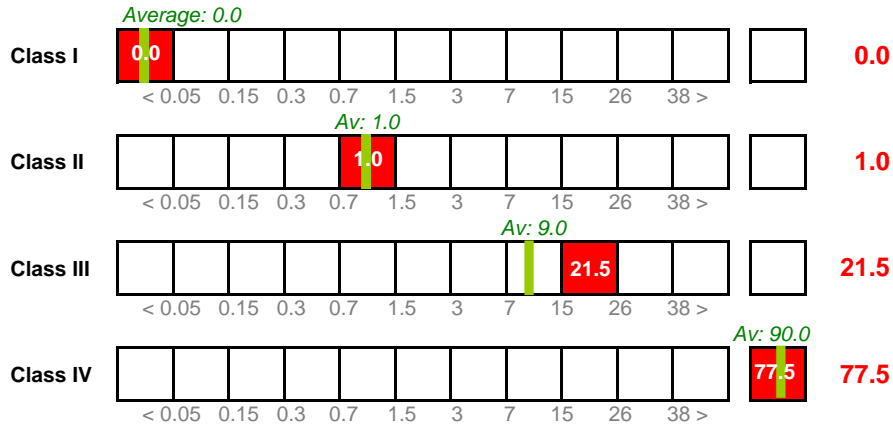

**Justification** Due to the substantial amount of lead-based paint remaining present and exposed in all rooms, the chance of a serious outcome is increased.



**RATING SCORES AFTER IMPROVEMENT**

**IMPROVE** Likelihood to 1 in 5,600 Outcomes to 0.0 | 1.0 | 10.0 | 89.0 %

**Justification** The old paint should be stripped by a competent person using proper protection. The occupants should be temporarily rehoused during the stripping and re-painting. The lead pipework should be removed and new plastic or copper pipes installed.



Av: Nos Average likelihood, outcomes and HHSRS score for hazards associated with lead for persons aged under 3 years in 1920-45 non-HMOs.

# RADIATION (RADON)

HHSRS VERSION 2

<b>Vulnerable age</b>	Elderly persons, lifetime exposure	<b>Multiple locations</b>	Yes	No
<b>Related hazards</b>	Damp	<b>Secondary hazards</b>	Yes	No

Front elevation



B) Rear dining room floor

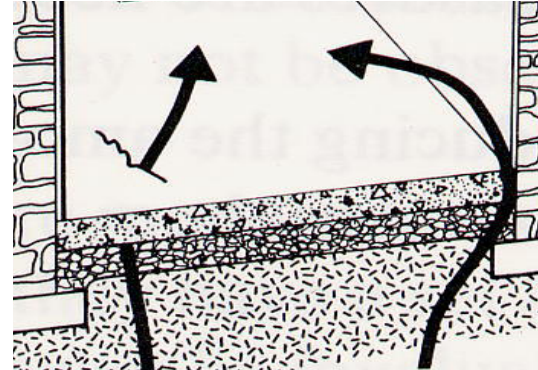

C) Front living room & spine wall

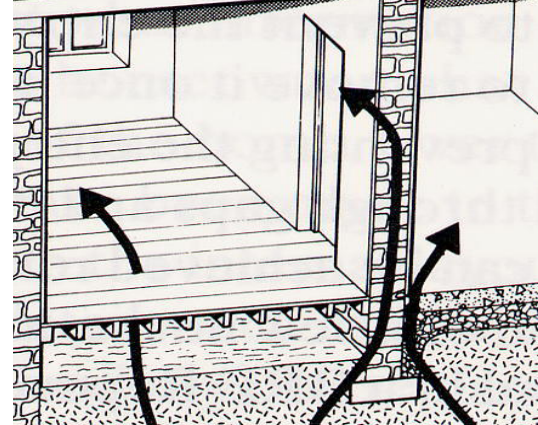

Radon/rating table

Radon Bam <sup>-3</sup>	Likelihood 1 in	Rating score	Rating band
800	277	3,285	<b>B</b>
400	518	1,757	<b>C</b>
200	1,000	910	<b>D</b>
150	1,322	688	<b>D</b>
100	1,961	464	<b>E</b>
50	3,902	233	<b>E</b>
25	7,853	116	<b>F</b>

## DESCRIPTION OF HAZARDS

**Dwelling:** 1850's 4 bedroomed detached farmhouse

**Background:** This large, two storey detached farmhouse is in a radon affected area. It is built with random rubble stone, rendered walls and has a variety of floor constructions.

- A) Kitchen:** At the rear of the house, there is a flag stone floor to the kitchen, the flags being laid directly onto the soil. Most of the kitchen walls show signs of rising damp.
- B) Dining room:** There is a solid concrete floor to the rear dining room and like the kitchen floor this also shows evidence of rising damp, as do two of the walls.
- C) Front rooms:** The two ground floor front rooms have butt jointed, suspended timber floors. There are two air-vents to the front wall, but no others, and rising damp in the spine wall.

## LIST OF RELEVANT MATTERS

LIKELIHOOD & OUTCOMES	A	B	C	# Secondary hazards	A	B	C
<i>a</i> Timber ground floor	-	-	3	- None	-	-	-
<i>b</i> Disrepair to solid floor	3	1	-				
<i>c</i> Lack of DPM	3	2	2				
<i>d</i> Sealing around services	3	-	-				
<i>e</i> Ventilation rates	-	-	-				
<i>f</i> Open fires	-	-	-	<b>Key</b>	3	Seriously defective	
<i>g</i> Remedial measures	-	-	-		2	Defective	
<i>h</i> Extractor fans	-	-	-		1	Not satisfactory	
<i>i</i> Private water supply	-	-	-		-	Satisfactory/NA	

**HEALTH AND SAFETY RATING SYSTEM SCORES**

Pre 1920 House

LIKELIHOOD Low → High

1 in 100

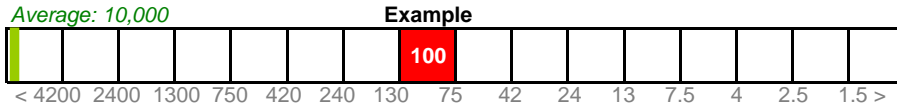

**Justification** There is sufficient evidence to suggest a radon problem and subsequent measurements show a level of over 2,000 Bqm<sup>-3</sup>, way above both the average for radon affected areas and the recommended action level of 200 Bqm<sup>-3</sup>. Information from NRPB and other sources (see table overleaf) indicates that this would give an annual risk of cancer of around 1 in 100.

**OUTCOMES**

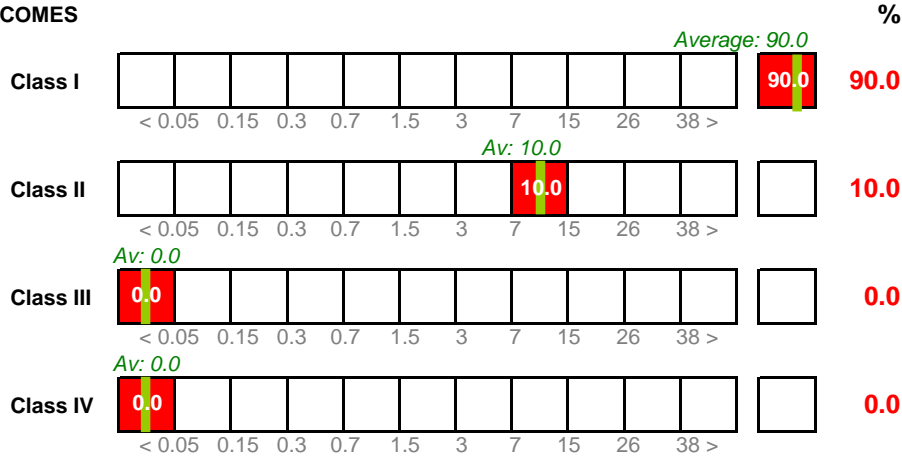

**Justification** The radon level does not alter the spread of outcomes.

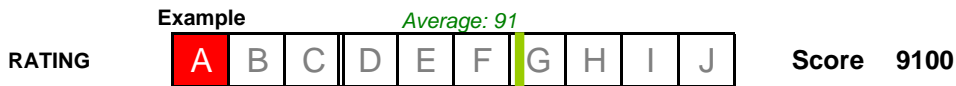

**RATING SCORES AFTER IMPROVEMENT**

IMPROVE Likelihood to 1 in 3,200 Outcomes to 90.0 | 10.0 | 0.0 | 0.0 %

**Justification** The installation of a radon sump under the centre of the house, close to the spine wall, is found to reduce the radon level to just over 70 Bqm<sup>-3</sup> and thereby the likelihood to around 1 in 3,200 and the rating score to 284 - reducing the Band from A to E. As the dwelling is in a high radon gas risk area, some risk remains.



Av: Nos Average likelihood, outcomes and HHSRS score for radon for persons aged 60 to 64 years in all dwellings, following lifetime exposure



# RADIATION (RADON)

HHSRS VERSION 2

**Vulnerable age** Elderly persons, lifetime exposure  
**Related hazards** Damp

**Multiple locations** Yes No  
**Secondary hazards** Yes No

Front elevation



After improvement - extract vent



C) Front living room & spine wall

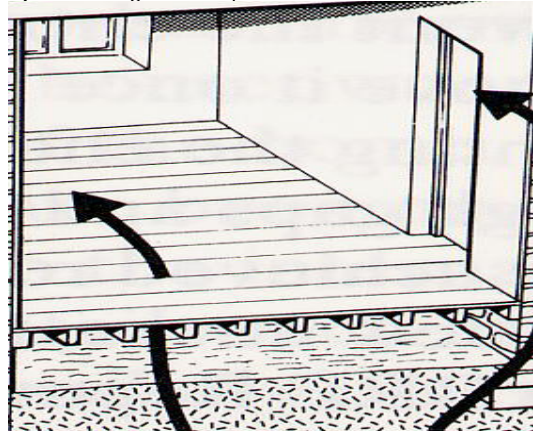

Radon/rating table

Radon Bqm <sup>-3</sup>	Likelihood 1 in	Rating score	Rating band
800	277	3,285	<b>B</b>
400	518	1,757	<b>C</b>
200	1,000	910	<b>D</b>
150	1,322	688	<b>D</b>
100	1,961	464	<b>E</b>
50	3,902	233	<b>E</b>
25	7,853	116	<b>F</b>

## DESCRIPTION OF HAZARDS

**Dwelling:** 1930's semi-detached house

**Background:** This is a 3 bedroomed semi-detached house built around 1930 in a radon affected area. It has solid 9 in brick external walls which are rendered and all of the ground floor rooms have suspended timber floors. The house is centrally heated but there is an open fire in the living room.

- A) Suspended timber floors:** The floors to the ground floor front and rear living rooms, kitchen and hall are all of tongued and grooved timber boards laid on joists, with a relatively shallow underspace below. Measurements show a radon level in the house of 800 Bqm<sup>-3</sup>.

## LIST OF RELEVANT MATTERS

### LIKELIHOOD & OUTCOMES

- a Timber ground floor
- b Disrepair to solid floor
- c Lack of DPM
- d Sealing around services
- e Ventilation rates
- f Open fires
- g Remedial measures
- h Extractor fans
- i Private water supply

**A**

3

-

2

-

-

2

-

-

-

### # Secondary hazards

- None

**A**

-

### Key

- 3 Seriously defective
- 2 Defective
- 1 Not satisfactory
- Satisfactory/NA



**HEALTH AND SAFETY RATING SYSTEM SCORES**

1920-45 House

LIKELIHOOD Low → High

1 in 320

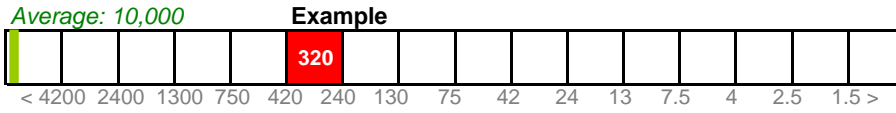

**Justification** There is sufficient evidence to suggest a radon problem and subsequent measurements show a level of nearly 800 Bqm<sup>-3</sup>, substantially above both the average for radon affected areas and the recommended action level of 200 Bqm<sup>-3</sup>. Information from NRPB and other sources (see table overleaf) indicates that this would give an annual risk of cancer of around 1 in 280.

**OUTCOMES**

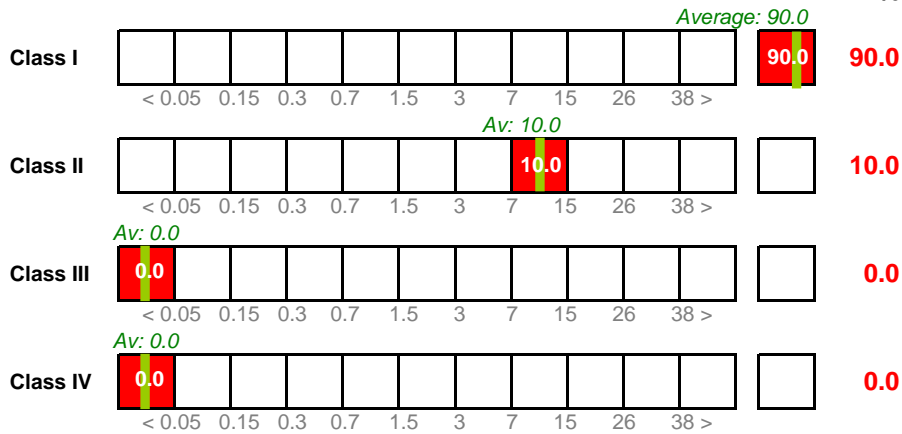

**Justification** The radon level does not alter the spread of outcomes. With the likelihood rounded up to 1 in 320, this average spread gives a score of 2843 and a rating of band B.

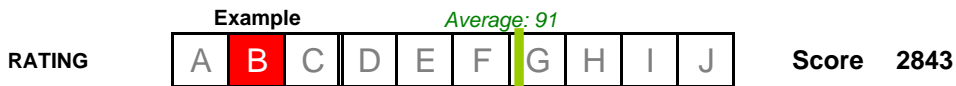

**RATING SCORES AFTER IMPROVEMENT**

IMPROVE Likelihood to 1 in 5,600 Outcomes to 90.0 | 10.0 | 0.0 | 0.0 %

**Justification** In this case, the installation of underfloor mechanical extract ventilation is found to reduce the radon level to 40 Bqm<sup>-3</sup> and thereby the likelihood to some 1 in 5,600 and the rating score to some 160. Thus, the rating band is reduced from B to F. As the dwelling is in a high radon gas risk area, some risk remains.



Av: Nos Average likelihood, outcomes and HHSRS score for radon for persons aged 60 to 64 years in all dwellings, following lifetime exposure

# RADIATION (RADON)

HHSRS VERSION 2

**Vulnerable age** Elderly persons, lifetime exposure      **Multiple locations** Yes      No  
**Related hazards** Damp      **Secondary hazards** Yes      No

Front elevation



Elevation of terrace



C) Solid floors and cavity walls (illustrative only)

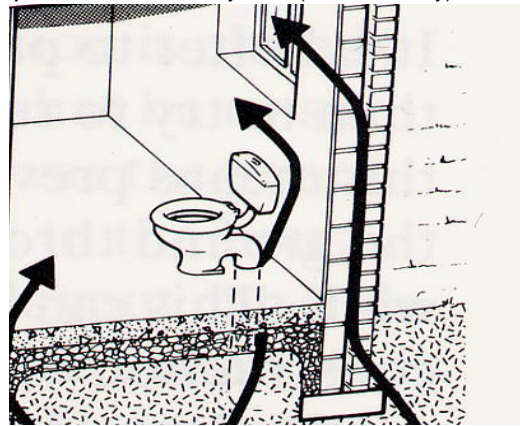

Radon/rating table

Radon Bqm <sup>-3</sup>	Likelihood 1 in	Rating score	Rating band
800	277	3,285	<b>B</b>
400	518	1,757	<b>C</b>
200	1,000	910	<b>D</b>
150	1,322	688	<b>D</b>
100	1,961	464	<b>E</b>
50	3,902	233	<b>E</b>
25	7,853	116	<b>F</b>

## DESCRIPTION OF HAZARDS

**Dwelling:** 1970's mid-terraced house

**Background:** This is the centre house in a terrace of five two storey houses built on a steeply sloping site in an area of the South West with generally high radon levels. All the houses in the terrace are affected by the gas but to varying degrees, the larger end houses having the highest levels. The centre house of the example has the lowest level in the terrace and with a radon measure of 196 Bqm<sup>-3</sup>, falls just below the radon action level. The other houses in the terrace have levels of 914, 739, 226 and 2,274 Bqm<sup>-3</sup>.

- C) Solid floors:** All the ground floor rooms have solid concrete floors. Built before radon protective measures became a requirement of the Building Regulations, all floors have a damp proof membrane but this of an insufficient specification to stop the ingress of radon gas around the joints with the walls and pipes and via the cavity walls.

## LIST OF RELEVANT MATTERS

### LIKELIHOOD & OUTCOMES

<i>a</i> Timber ground floor	-	<i>i</i> Private water supply	-
<i>b</i> Disrepair to solid floor	-		
<i>c</i> Lack of DPM	1	<b># Secondary hazards</b>	
<i>d</i> Sealing around services	3	- None	-
<i>e</i> Ventilation rates	-		
<i>f</i> Open fires	3		
<i>g</i> Remedial measures	-	<b>Key</b> 3 Seriously defective	1 Not satisfactory
<i>h</i> Extractor fans	-	2 Defective	- Satisfactory/NA

**HEALTH AND SAFETY RATING SYSTEM SCORES**

1946-79 House

LIKELIHOOD Low → High

1 in 1000

Average: 10,000

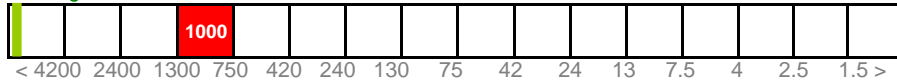

**Justification**

Due to the location of the terrace and its date of construction prior to the introduction of relevant Building Regulations, there is sufficient evidence to suggest a radon problem and subsequent measurements show a level of 196 Bqm<sup>-3</sup> in the example dwelling. Information from NRPB and other sources (see table overleaf) indicates that this would give an annual risk of cancer of around 1 in 1,000.

**OUTCOMES**

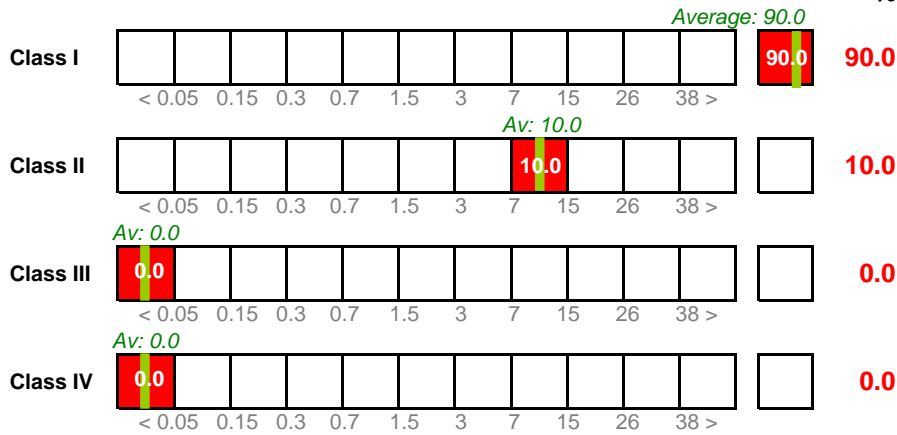

**Justification**

The radon level does not alter the spread of outcomes. With the likelihood at around 1 in 1000, this average spread gives a rating score of 910 and Band D.



**RATING SCORES AFTER IMPROVEMENT**

IMPROVE Likelihood to 1 in 5,600 Outcomes to 90.0 | 10.0 | 0.0 | 0.0 %

**Justification**

The high values in the terrace generally suggest a communal solution with two externally excavated sump systems fitted one at either end of block. This reduces the radon level in the centre house to 25 Bqm<sup>-3</sup> (and in the other houses to 13, 13, 21 and 13 Bqm<sup>-3</sup>).



Av: Nos Average likelihood, outcomes and HHSRS score for radon for persons aged 60 to 64 years in all dwellings, following lifetime exposure

# UNCOMBUSTED FUEL GAS

HHSRS VERSION 2

<b>Vulnerable age</b>	All ages	<b>Multiple locations</b>	Yes	<b>No</b>
<b>Related hazards</b>	Explosions, Carbon Monoxide etc	<b>Secondary hazards</b>	Yes	<b>No</b>

**A) Gas fire to ground floor front room**



Front elevation



Rear elevation



**DESCRIPTION OF HAZARDS**

**Dwelling:** 1920s semi-detached house

**A) Gas pipe and fire:** The gas fire fitted into the open fireplace in the front living room is old and obsolete. The joint between the fire and the opening is unsealed. However, more relevant is that the movement of the gas fire has loosened the joint between the pipe and the gas tap. There is no permanent means of ventilation to the room. Neither the fire nor the gas installations have been checked or serviced over the last five years.

**LIST OF RELEVANT MATTERS**

LIKELIHOOD	A	OUTCOME	A
a Gas supply	-	a Gas detector provision	2
b Gas installation	3	b Defects to detectors	3
c Gas appliances	3		
d Maintenance defects	3	<b># Secondary hazard</b>	<b>A</b>
e Siting of appliances	3	- None	-
		<b>Key</b>	
		3 Seriously defective	1 Not satisfactory
		2 Defective	- Satisfactory/NA

**HEALTH AND SAFETY RATING SYSTEM SCORES**

1920-45 House

LIKELIHOOD Low → High

1 in 10

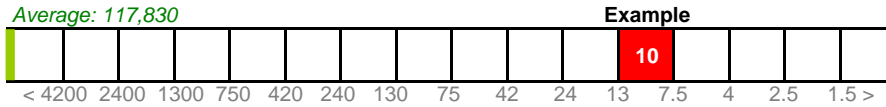

**Justification** Whether or not the fire is in use, there is a significant likelihood of uncombusted gas leaking into the room. With no means of permanent ventilation (particularly at high level) the gas will accumulate within the room.

**OUTCOMES**

%

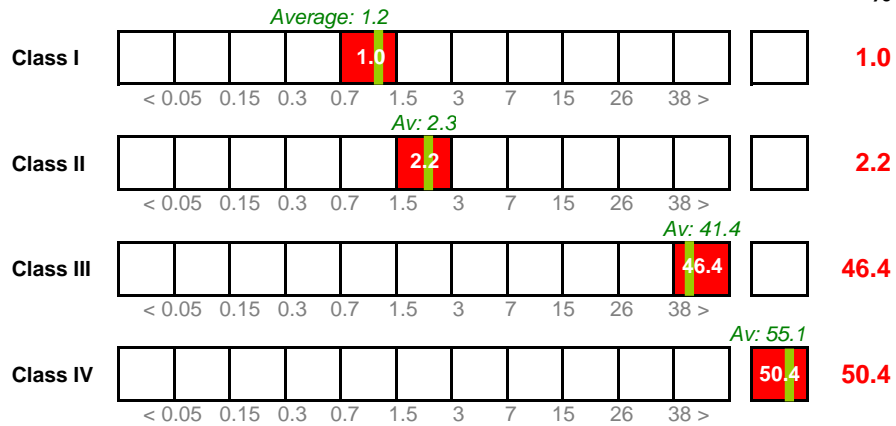

**Justification** There is nothing to suggest that the harm outcomes will differ from the average.



**RATING SCORES AFTER IMPROVEMENT**

**IMPROVE** Likelihood to 1 in 1,800 Outcomes to 1.0 | 2.2 | 46.4 | 50.4 %

**Justification** The gas installations and this gas fire (and any other gas appliances) should be properly tested and any works carried out. This would probably include renewal of the fire and of the pipe work. In addition, permanent means of ventilation (at high level) should be installed. These works would reduce the likelihood substantially but this would still remain higher than average due to the presence of individual gas appliances in the habitable rooms.



Av: Nos Average likelihood, outcomes and HHSRS score for uncombusted fuel gas for all persons in 1920-45 houses.



# VOCs (VOLATILE ORGANIC COMPOUNDS)

HHSRS VERSION 2

<b>Vulnerable group</b>	All ages	<b>Multiple locations</b>	Yes	No
<b>Related hazards</b>	Excess Heat	<b>Secondary hazards</b>	Yes	No

Roof light to bedroom



Corner of bedroom prior to redecoration



Front elevation

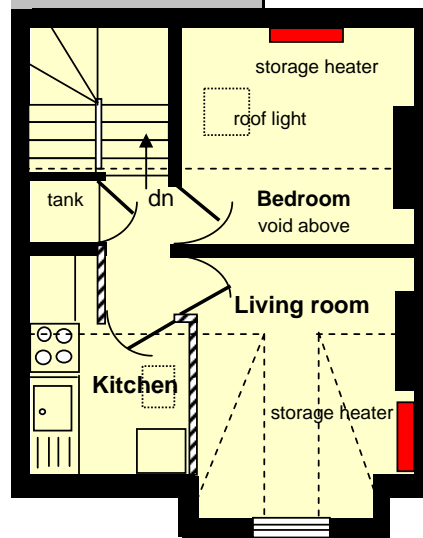

## DESCRIPTION OF HAZARDS

Plan of flat

**Dwelling:** Pre 1920 non-self contained attic flat

**Background:** This is a one-bedroomed attic flat in a three-storey late Victorian house in Inner London. It was converted in the 1950s to provide a self contained flat on the ground floor and three non-self contained flats on the upper floors. The flat being assessed shares a bathroom and a separate w.c. on the first floor with the two flats on that level, but has its own small kitchen.

**Ventilation:** The full height living room window has one low opening casement. The bedroom has a small openable roof light, while the kitchen is lit by fixed transparent tiles and ventilated by a small extractor above the electric cooker that discharges into the roof void.

**Redecoration:** The ground floor self-contained flat is vacant and the landlord has taken the opportunity to redecorate the whole of the house internally and to lay chipboard over the floors to the common parts and the vacant flat. The work has been done by a local odd-job man and is only now nearing completion after several weeks. As well as the solvent in the adhesive used to glue the chipboard, the paints used are from old stock and have high VOC emission levels.

## LIST OF RELEVANT MATTERS

LIKELIHOOD & OUTCOMES	A	# Secondary hazards	A
a VOC emitting materials	3	None	-
b VOC emitting treatments	3		
c Inadequate ventilation	3		
d Disrepair - to ventilation system	-		
		<b>Key</b>	
		3 Seriously defective	1 Not satisfactory
		2 Defective	- Satisfactory/NA

**HEALTH AND SAFETY RATING SYSTEM SCORES**

Pre 1920 non s.c. flat

LIKELIHOOD Low → High

1 in 10

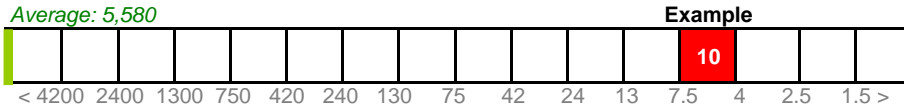

**Justification** The likelihood of harm in the attic flat is increased by several factors - that the flat has been occupied during the works; the poor provision for ventilation in the flat; the extended duration of the work; the use of materials with high emission rates; and the extent of the redecoration, with fumes coming from the common parts and all other flats as well as from within the flat itself.

OUTCOMES Low → High

%

Average: 0.1

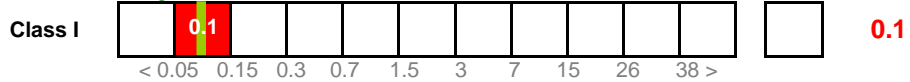

Av: 0.1

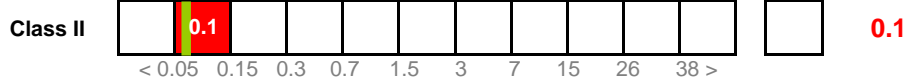

Av: 1.0



Av: 98.8



**Justification** Although the occupants cannot escape the fumes and this will increase the likelihood of harm, there is nothing to suggest changes to the spread of harms.

Example

Average: <1

RATING



Score 238

**RATING SCORES AFTER IMPROVEMENT**

IMPROVE Likelihood to 1 in 5,600 Outcomes to 0.1 | 0.1 | 1.0 | 98.8 %

**Justification** To avoid the problem arising, materials with low emission rates should have been used, and the work carried out with proper precautions and as quickly as possible. The only solution now is to ensure adequate ventilation to allow dispersal of the fumes. (Note that more substantial works are also required to this flat to improve the ventilation and its energy efficiency - see WE 3.1 V2.)

Improved

NEW RATING



Score <1

Av Nos: Average likelihood, outcomes and HHSRS score for hazards from VOCs for persons of all aged in all dwellings, 1997-99.



## CROWDING AND SPACE

HHSRS VERSION 2

**NOTE** - The HHSRS assessment for Crowding and Space differs from other Hazards. As with all Hazards, the dwelling is first assessed disregarding the current occupiers. In most cases, this will mean that the dwelling will be satisfactory (ie, average) having regard to the space available for sleeping, living and recreation. A supplemental stage is necessary taking into account the current occupiers to determine whether the dwelling is crowded - ie, is there a mis-match between the size of the household and the dwelling. It is this Adjusted Hazard Score which should be taken into account in deciding whether action is necessary.

# CROWDING AND SPACE

HHSRS VERSION 2

<b>Vulnerable age</b>	All ages of person	<b>Multiple locations</b>	Yes	<b>No</b>
<b>Related hazards</b>	Personal hygiene, Sanitation Food safety	<b>Secondary hazards</b>	Yes	<b>No</b>

Front elevation



Rear elevation



## DESCRIPTION OF HAZARDS

**Dwelling:** 1870 mid-terraced house

**Background:** This is a late 19th century mid terraced house with a two-storey back addition. The dwelling comprises two bedrooms and a combined bathroom/wc compartment to the first floor, and one 'knocked through' living room and a kitchen to the ground floor. The original outside wc compartment is still available. There is a small rear yard contained by walls, with rear access via a gate leading to a back lane.

**Occupation:** The current household comprises the mother and father, and their three children, two girls aged 13 and 11 and a boy aged 9 years.

## LIST OF RELEVANT MATTERS

LIKELIHOOD & OUTCOMES	A	# Secondary hazards	A
<i>a</i> Living area	-	- None	-
<i>b</i> Kitchen area	-		
<i>c</i> Personal washing area	-		
<i>d</i> Washing area door	-		
<i>e</i> Sanitary accommodation	-		
<i>f</i> Sanitary accommodation door	-		
<i>g</i> Number of bedrooms	-	<b>Key</b>	3 Seriously defective
<i>h</i> Bedroom size	-		2 Defective
<i>i</i> Bedroom location	-		1 Not satisfactory
<i>j</i> Recreational space	-		- Satisfactory/NA

**HEALTH AND SAFETY RATING SYSTEM SCORES**

Pre 1920 House

LIKELIHOOD Low → High

1 in 5,600

Average: 6,950

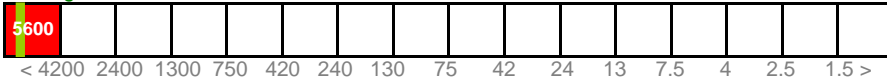

**Justification** For the purposes of the Rating System, the current occupation is disregarded in the assessment of the dwelling. The dwelling provides adequate sleeping, living and recreational space for up to 4 persons (irrespective of age). On this basis, the dwelling is satisfactory. However, there is a mis-match between the current occupying household and the house - on which see below.

**OUTCOMES**

%

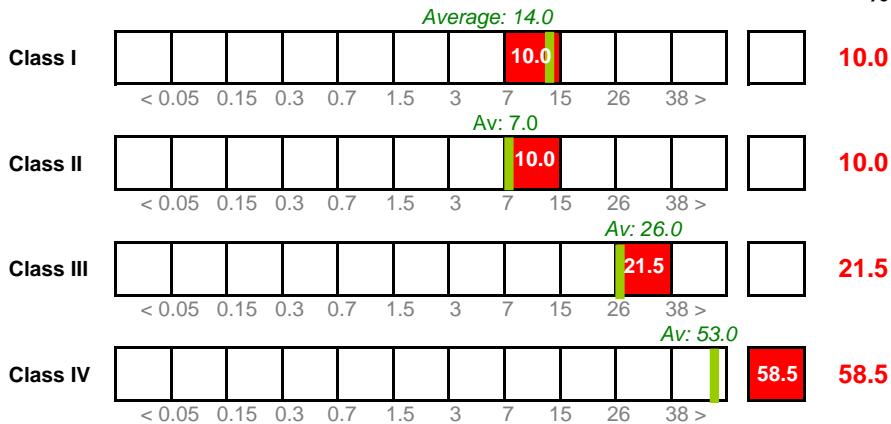

**Justification** There is no reason to vary the outcomes from the average.



**RATING SCORES TAKING ACCOUNT OF CURRENT OCCUPANTS**

ADJUST TO Likelihood to 1 in 320 Outcomes to 10.0 | 10.0 | 21.5 | 58.5 %

**Justification** Unlike other hazards, with lack of space and overcrowding, the severity of the risk will depend on the number of current occupants in the dwelling. In this case, the household comprises 5 persons and this dwelling is not big enough for such a household. This increases the likelihood of a harmful occurrence, but not the spread of health outcomes, giving a hazard score of 365 and a rating of band E.

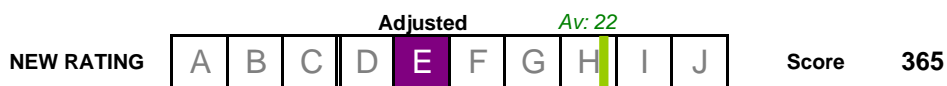

Av: Nos Average likelihood, outcomes and HHSRS score for crowding and space for all persons in pre 1920 houses not in multiple occupation, 1997-99

## CROWDING AND SPACE

HHSRS VERSION 2

**NOTE** - The HHSRS assessment for Crowding and Space differs from other Hazards. As with all Hazards, the dwelling is first assessed disregarding the current occupiers. In most cases, this will mean that the dwelling will be satisfactory (ie, average) having regard to the space available for sleeping, living and recreation. A supplemental stage is necessary taking into account the current occupiers to determine whether the dwelling is crowded - ie, is there a mis-match between the size of the household and the dwelling. It is this Adjusted Hazard Score which should be taken into account in deciding whether action is necessary.

# CROWDING AND SPACE

HHSRS VERSION 2

<b>Vulnerable age</b>	All ages of person	<b>Multiple locations</b>	Yes	<b>No</b>
<b>Related hazards</b>	Personal hygiene, sanitation food safety, & ergonomics	<b>Secondary hazards</b>	Yes	<b>No</b>



## DESCRIPTION OF HAZARDS

**Dwelling:** 1900 mid-terraced 2 bedroomed house

**Background:** This is a late 19th century mid terraced house, comprising, on the first floor, a front bedroom and a smaller back bedroom and combined bathroom and wc at the rear. On the ground floor there is a front living room, rear dining/kitchen and through hall. There is a small rear yard, with rear access via a gate leading to a back lane.

**Occupying Household:** The current household comprises a couple, and their four children, a 12 year old girl, twin boys aged 9 and a boy aged 5 years. The four children sleep in bunk beds in the rear bedroom and the parents in the front bedroom.

## LIST OF RELEVANT MATTERS

LIKELIHOOD & OUTCOMES	A	# Secondary hazards	A
<i>a</i> Living area	-	- None	-
<i>b</i> Kitchen area	-		
<i>c</i> Personal washing area	-		
<i>d</i> Washing area door	-		
<i>e</i> Sanitary accommodation	-		
<i>f</i> Sanitary accommodation door	-		
<i>g</i> Number of bedrooms	-	<b>Key</b>	3 Seriously defective
<i>h</i> Bedroom size	-		2 Defective
<i>i</i> Bedroom location	-		1 Not satisfactory
<i>j</i> Recreational space	-		- Satisfactory/NA

**HEALTH AND SAFETY RATING SYSTEM SCORES**

Pre 1920 House

LIKELIHOOD Low → High

1 in 5,600

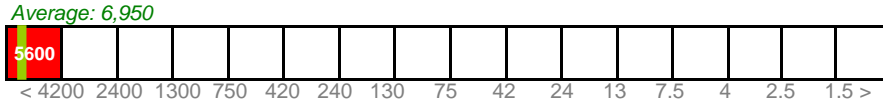

**Justification** As for all hazards, the current occupation is disregarded in the HHSRS assessment of the dwelling. The dwelling provides adequate sleeping, living and recreational space for up to 3 persons (irrespective of age and sex). On this basis, the dwelling is satisfactory. However, there is a mis-match between the current occupying household and the house on which see below.

**OUTCOMES**

%

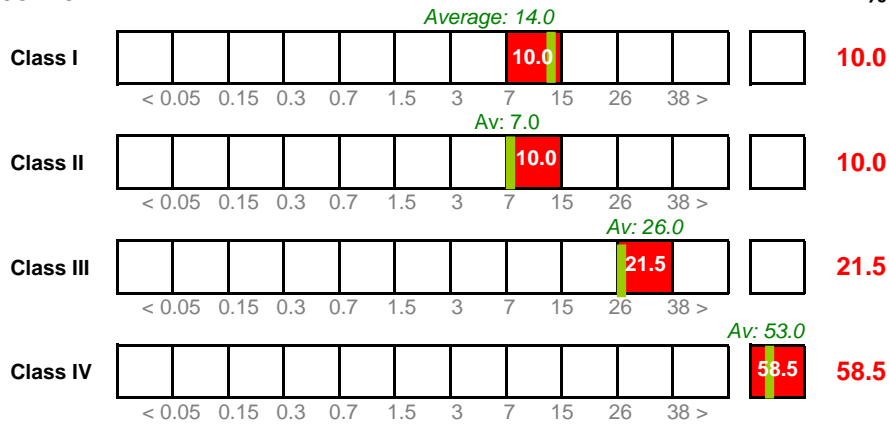

**Justification** There is no reason to vary the outcomes from the average.



**RATING SCORES TAKING ACCOUNT OF CURRENT OCCUPANTS**

ADJUST TO Likelihood to 1 in 56 Outcomes to 10.0 | 10.0 | 21.5 | 58.5 %

**Justification** Unlike other hazards, with Crowding and Space the severity of the risk will depend on the number of current occupants in the dwelling and the space available. In this case, the household comprises 6 persons and this dwelling is suitable for occupation by 3 persons. This increases the likelihood of a harmful occurrence, but not the spread of health outcomes, giving a hazard score of 2,089 and a rating of band B.



Av: Nos Average likelihood, outcomes and HHSRS score for crowding and space for all persons in pre 1920 houses not in multiple occupation, 1997-99

# ENTRY BY INTRUDERS

HHSRS VERSION 2

<b>Vulnerable age</b>	All ages	<b>Multiple locations</b>	Yes	No
<b>Related hazards</b>	Fire	<b>Secondary hazards</b>	Yes	No

**A) Door to flat**



Front elevation



Rear elevation



**DESCRIPTION OF HAZARDS**

**Dwelling:** Non-self contained flat in 1900's converted house (HMO)

**Background:** This is a first floor flat in a three storey, plus basement, house converted into four non-self contained units. The house is located in an inner city area where there are many similar HMOs and is known to have a high crime rate. Entry to the flat is from a common staircase and landing. There is a shared bathroom on the first floor. Neither the house nor any of the individual units have a burglar alarm system. Nor is there controlled access (e.g. an entry-phone system) for the front door.

**A) Entrance doors:** The entrance door to the flat is glazed with non-safety, obscured glass. The lock is a standard, externally mounted, Yale type. There is a small externally mounted bolt below the lock. On the front door of the house, which is also glazed with the same non-safety obscured glass, there is a lock of a similar type, but no other security devices.

**LIST OF RELEVANT MATTERS**

LIKELIHOOD & OUTCOMES	A	# Secondary hazards	A
a Location	3	- None	-
b Defensible space	1		
c Lighting, incl. security lighting	1		
d Pedestrian routes	2		
e Housing layout	-		
f1 Doors and windows - repair	3		
f2 Doors and windows - locks	2		
g Door viewers	3		
h Door chains	3		
j Concierge etc	3		
k Burglar alarms	3		
		<b>Key</b>	3 Seriously defective
			2 Defective
			1 Not satisfactory
			- Satisfactory/NA



**HEALTH AND SAFETY RATING SYSTEM SCORES**

Pre 1920 Non s.c. Flat

LIKELIHOOD Low → High

1 in 3

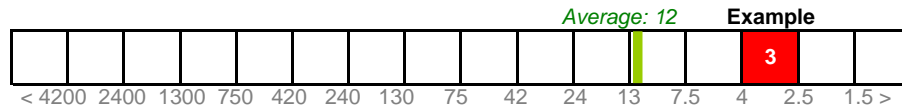

**Justification** For an elderly person in this flat, the likelihood of suffering harm either through actual injuries caused by an intruder or, more probably, due to the constant fear of an intruder and burglary is likely to be much higher than average because of the nature of the area and actual number of local burglaries and repeat burglaries, the poor internal security of the flat and external security of the house and the type of accommodation.

**OUTCOMES**

%

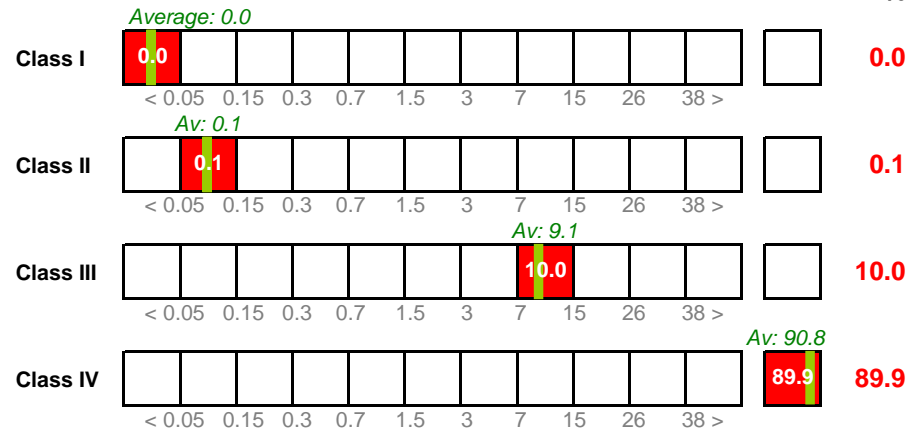

**Justification** Although the likelihood of injury as a result of crime or the fear of crime is much higher than average for this flat, the resulting actual spread of harms so caused is no higher than average.

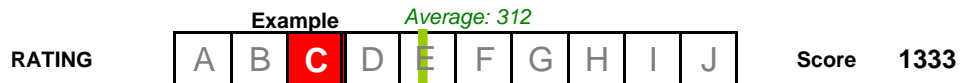

**RATING SCORES AFTER IMPROVEMENT**

IMPROVE Likelihood to 1 in 18 Outcomes to 0.0 | 0.1 | 10.0 | 89.9 %

**Justification** Changing the doors and locks on both front door to the house and flat and installing an entry phone to the flat is likely to improve the risk of both actual entry by intruders and the fear of crime for the occupant to below average for houses in multiple occupation. However, due to the nature of the area and type of accommodation, the likelihood will still remain relatively high.

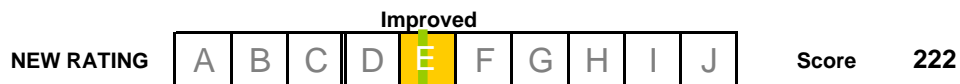

Av: Nos Average likelihood, outcomes and HHSRS score for hazards from entry by intruders for all persons in all houses in multiple occupation (HMOs), 1999-2000

# LIGHTING

HHSRS VERSION 2

**Vulnerable age** All ages  
**Related hazards** None

**Multiple locations** Yes **No**  
**Secondary hazards** Yes **No**



Rear elevation



Ground floor rear kitchen/diner

## DESCRIPTION OF HAZARDS

**Dwelling:** 1960's, 3 bedroom detached house.

The dwelling faces almost directly West. It is now let privately (and has been for the last three years) through the local University accommodation agency. It is currently occupied by four unrelated students. The height of the Leylandii hedge, which is within the boundary of the property, blocks any direct sunlight into the ground and first floor rear rooms. The hedge makes the ground floor kitchen and dining area particularly dark.

## LIST OF RELEVANT MATTERS

### LIKELIHOOD & OUTCOMES

<i>a</i>	Obstruction - of windows	3
<i>b</i>	Size, shape and position	-
<i>c</i>	Position of artificial lighting	-
<i>d</i>	Control of artificial lighting	-
<i>e</i>	Glare etc	-
<i>f</i>	Window view	-
<i>g</i>	Outlook	-

### # Secondary hazards

	none
<b>Key</b>	<b>3</b> Seriously defective
	<b>2</b> Defective
	<b>1</b> Not satisfactory
	- Satisfactory

**HEALTH AND SAFETY RATING SYSTEM SCORES**

1946-79 House

LIKELIHOOD Low → High

1 in 32

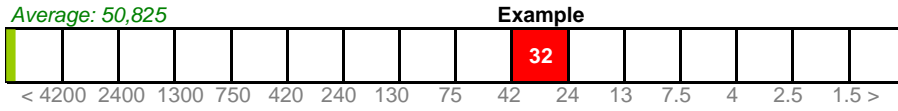

**Justification** The windows to the rear elevation are of adequate size and are well located so that, if unobstructed, the dwelling there would be adequate natural lighting. However, the position and height of the Leylandii hedge obstructs daylight with the result that there is inadequate daylight penetration into the rear rooms. As one of these is the kitchen/diner, the likelihood of a harmful occurrence, is significantly increased. Concerns about getting the hedged removed/lopped may also add to the psychological harm.

**OUTCOMES**

%

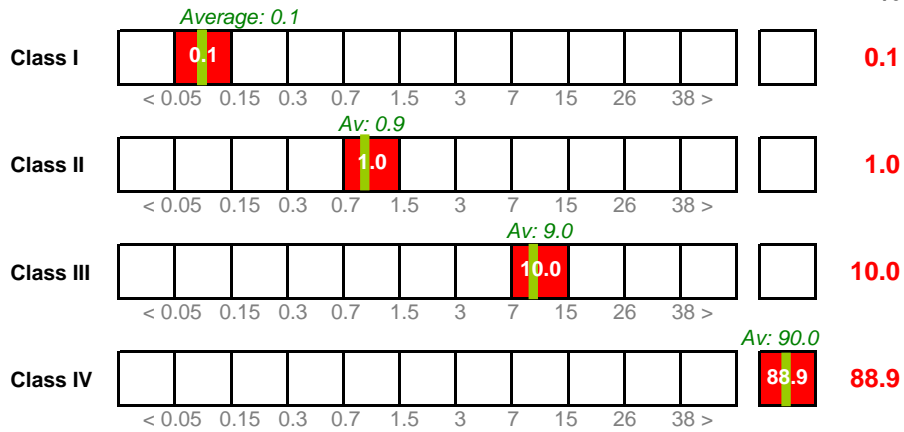

**Justification** There is nothing to suggest that the outcomes will vary from the average.



**RATING SCORES AFTER IMPROVEMENT**

**IMPROVE** Likelihood to 1 in 5,600 Outcomes to 0.1 | 1.0 | 10.0 | 88.9 %

**Justification** The hedge should be cut down to a height of less than 2 metres or removed and replaced with a fence. Either of these would remove the obstruction and allow adequate daylight penetration.



*Av: Nos* Average likelihood, outcomes and HHSRS score for hazards from inadequate lighting for all persons in all dwellings, 1995-96

# LIGHTING

HHSRS VERSION 2

<b>Vulnerable age</b>	All ages	<b>Multiple locations</b>	<b>Yes</b>	<b>No</b>
<b>Related hazards</b>	Fire	<b>Secondary hazards</b>	Yes	No



Front elevation

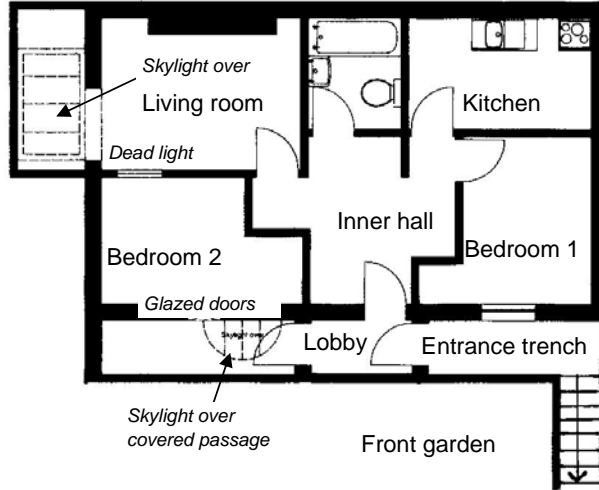

Plan of basement flat



Skylight over front passage

## DESCRIPTION OF HAZARDS

**Dwelling:** Basement flat under Georgian villa

This two bedroom basement flat, in a large 4-storey Georgian villa converted into self-contained flats, lies almost totally underground. Only the first bedroom has a normal window to the outside and this overlooks a narrow entrance trench. The living room is lit by a large skylight constructed over the adjacent light well which forms an extension to the room. The second bedroom is lit by borrowed light through a deadlight from the living room and through glazed doors from the adjacent front passage which is lit by a smaller skylight. The mechanically ventilated kitchen, bathroom, and inner hall have no means of natural lighting. There are no normal eye-level views from any of the rooms in the flat, other than a restricted view of the garden from the 1st bedroom.

## LIST OF RELEVANT MATTERS

### LIKELIHOOD & OUTCOMES

<i>a</i>	Obstruction - of windows	-
<i>b</i>	Size, shape and position	3
<i>c</i>	Position of artificial lighting	-
<i>d</i>	Control of artificial lighting	-
<i>e</i>	Glare etc	-
<i>f</i>	Window view	3
<i>g</i>	Outlook	3

### # Secondary hazards

<b>Key</b>	<b>3</b>	Seriously defective
	<b>2</b>	Defective
	<b>1</b>	Not satisfactory
	-	Satisfactory

**HEALTH AND SAFETY RATING SYSTEM SCORES**

Pre 1920 converted s/c Flat

LIKELIHOOD Low → High

1 in 1

Average: 50,825

Example

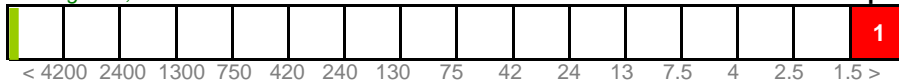

**Justification** Wherever you are in this dwelling, you would be aware that it was built underground. Only the first bedroom provides anything near the natural lighting conditions and outlook that one would expect from a dwelling. The living room has barely adequate light but no outlook, while all the remaining rooms are clearly devoid of both natural light and any outlook whatsoever. Apart from the difficulty of reading without artificial light, it is likely that most people would also suffer some psychological harm from living in the dwelling for a year or more.

**OUTCOMES**

%

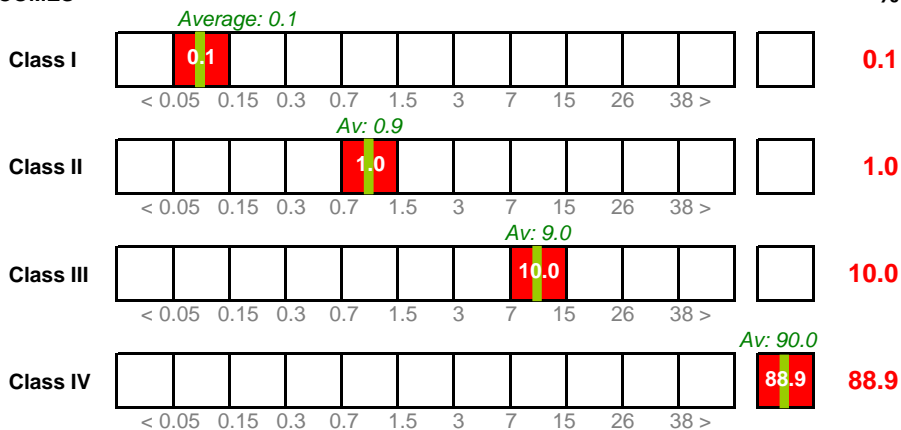

**Justification** There is nothing to suggest that the outcomes will vary from the average.

Example

Average: <1

RATING



Score 5889

**RATING SCORES AFTER IMPROVEMENT**

**IMPROVE** Likelihood to 1 in 180 Outcomes to 0.1 | 1.0 | 10.0 | 88.9 %

**Justification** To improve the natural lighting and outlook from this dwelling would require the digging out of the side garden to form a series of terraces dropping down to the living room and 2nd bedroom respectively. However, both the kitchen and bathroom would need to remain internal. Consequently, the score would still remain higher than average after such improvement.

NEW RATING



Score 32

Av: Nos Average likelihood, outcomes and HHSRS score for hazards from inadequate lighting for all persons in all dwellings, 1995-96

# NOISE

HHSRS VERSION 2

**Vulnerable age** All ages  
**Related hazards** None

**Multiple locations** Yes  
**Secondary hazards** Yes **No**  
**No**

Train passing window



Front elevation



Rear boundary fence



## DESCRIPTION OF HAZARDS

**Dwelling:** 5 storey Victorian mid-terraced house.

**Background:** The dwelling being assessed is a ground floor flat in a five storey (including basement and attic) mid terraced house converted into five self contained flats. Entry to the flat, which comprises a living room at the front of the house and bedroom and kitchen at the rear, plus an internal bathroom, is from the common hall.

- A) Location of house:** The house is located next to a parade of shops on a main arterial road running out of London. This road provides access to the motorway and is used by heavy goods vehicles as well as for long distance and local car journeys. Immediately behind the short rear yard and garden is the main London to Scotland rail line. The line is used by high speed trains, local diesel trains and goods trains. The main living room of the flat overlooks the main road and the bedroom and kitchen the rail line. All windows are traditional single glazed double hung sashes, and many particularly at the rear are ill-fitting and in disrepair.

## LIST OF RELEVANT MATTERS

LIKELIHOOD & OUTCOMES	A	# Secondary hazards	A
a Site of dwelling	3	- None	-
b Internal insulation	-		
c External insulation	3		
d Disrepair - windows/doors	2	<b>Key</b> 3	Seriously defective
e Siting of plumbing etc	-	2	Defective
f Equipment - noisy	-	1	Not satisfactory
g Door closers	-	-	Satisfactory/NA

**HEALTH AND SAFETY RATING SYSTEM SCORES**

Pre 1920 Non s.c. Flat

LIKELIHOOD Low → High

1 in 2

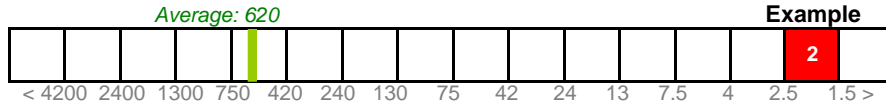

**Justification** There is no way the habitable rooms in the flat can be used without suffering from the noise caused by the road and train traffic. It would interfere with all activities, including sleeping patterns. While some people may be more tolerant of traffic noise than others, the likelihood of it causing some adverse health effects to a typical resident at some period during a year's exposure would be very high.

**OUTCOMES**

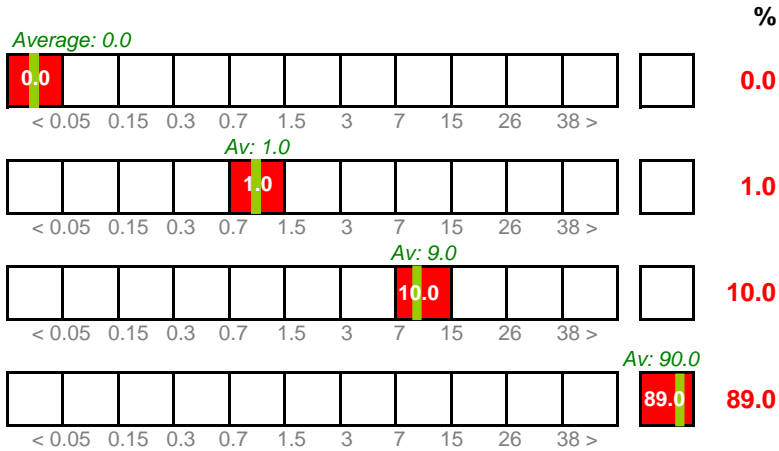

**Justification** Despite the likelihood being high, the fact that the noise is largely confined to general road and rail traffic noise and does not arise from specific disturbances caused by neighbours, means that the health outcomes are unlikely to any higher than average for this hazard. However, due to the very high incidence, the HHSRS result is still very high with a score of 2445 and band B rating.



**RATING SCORES AFTER IMPROVEMENT**

IMPROVE Likelihood to 1 in 18 Outcomes to 0 | 1.0 | 10.0 | 89 %

**Justification** Secondary glazing should be fitted to all windows (or double glazing with a sufficient gap between the panes to reduce noise penetration). However, because of its position, it will not be practicable to reduce the problem to the average levels.

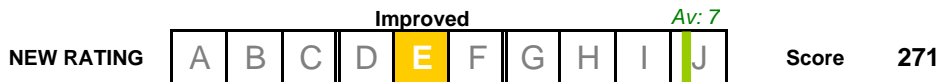

Av: Nos Average likelihood, outcomes and HHSRS score for hazards associated with noise for all persons in pre 1920 houses in multiple occupation (HMO)..



# NOISE

HHSRS VERSION 2

Vulnerable age All ages  
 Related hazards Fire

Multiple locations Yes  
 Secondary hazards Yes No

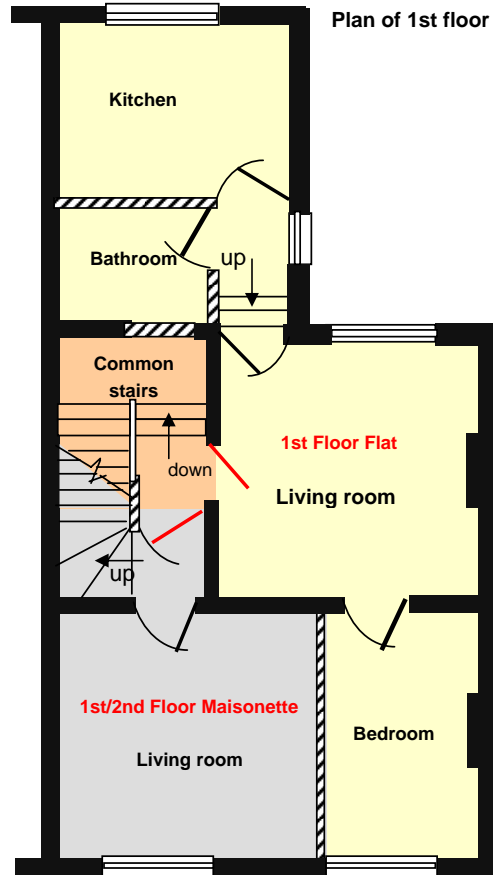

## DESCRIPTION OF HAZARDS

Dwelling: 1st floor flat in Regency mid-terraced house.

**Background:** This is a four storey Regency terraced house, with a two storey back addition, situated on a quiet street. The house was converted in the 1960s to provide four self-contained flats for rent - with flats in the basement and on the ground floor, a one bedroom flat on the first floor and a further maisonette on the first and top floors. The large first floor front room in the original house has been divided with a partition wall to provide the bedroom for the 1st floor flat and the living room of the 1st/2nd floor maisonette. This partition wall provides poor sound insulation between the two dwellings. The other internal and external 'party' walls to the first floor flat follow the original structural walls and provide adequate sound insulation, as do the floors and ceilings which are of traditional timber and lath and plaster construction.

## LIST OF RELEVANT MATTERS

LIKELIHOOD & OUTCOMES	A	# Secondary hazards	A
a Site of dwelling	-	- None	-
b Internal insulation	3		
c External insulation	-		
d Disrepair	-	<b>Key</b>	
e Siting of plumbing	-	3 Seriously defective	
f Equipment - noisy	-	2 Defective	
g Door closers	-	1 Not satisfactory	
		- Satisfactory/NA	

**HEALTH AND SAFETY RATING SYSTEM SCORES**

Pre 1920 converted s/c Flat

LIKELIHOOD Low → High

1 in 6

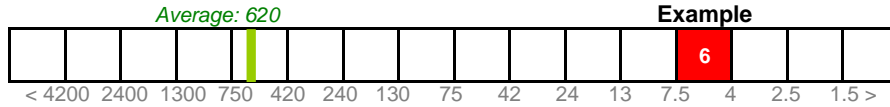

**Justification** The partition wall dividing the original front first floor room comprises 4 by 2 inch studs with plasterboard and skim both sides, with no insulation or filling of any kind. Although solidly built, the construction of this wall and the fact that it separates the living room in the 1st/2nd floor maisonette from the only bedroom in the 1st floor flat, means that there is a high likelihood that any occupant/s of that 1st floor flat will be disturbed by normal activity in the maisonette and will lose privacy (and vice versa).

**OUTCOMES**

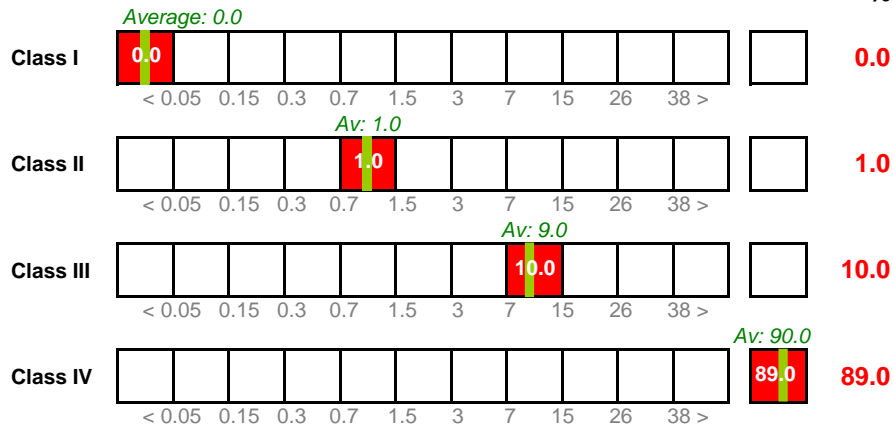

**Justification** Despite the high likelihood of activity in the maisonette causing some disturbance to the occupant/s of the flat, particularly at night, the spread of health outcomes is judged to be average for the hazard.



**RATING SCORES AFTER IMPROVEMENT**

IMPROVE Likelihood to 1 in 1,000 Outcomes to 0 | 1.0 | 10.0 | 89 %

**Justification** Demolishing the existing internal 'party' wall between the the bedroom of the first floor flat and the living room of the top maisonette and replacing it with one built to current Building Regulation standards would reduce the likelihood to better than average and the outcomes to average for pre 1920 converted dwellings. However, to improve fire safety, other works are required to avoid the only means of escape from the bedroom being via the living room.



Av: Nos Average likelihood, outcomes and HHSRS score for hazards associated with noise for all persons in pre 1920 houses in multiple occupation, 1997-99.

# DOMESTIC HYGIENE (PESTS)

HHSRS VERSION 2

<b>Vulnerable age</b>	All ages	<b>Multiple locations</b>	Yes	No
<b>Related hazards</b>	Falls on level, Damp	<b>Secondary hazards</b>	Yes	No

A) Kitchen floor



Front elevation



A) Plan

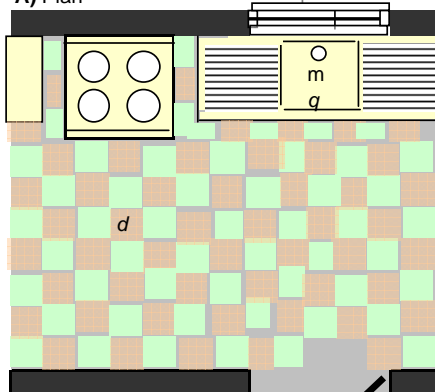

**DESCRIPTION OF HAZARD/S** Dwelling: Early 1960's, semi-detached non-trad house

A) **Kitchen floor:** The main photograph shows the kitchen floor looking through an internal door. Throughout the kitchen, the original thermoplastic plastic tiles have become unstuck due to rising damp through the concrete sub-floor and have also become brittle and broken with age. The remaining floors in the dwelling, although similarly damp on the ground floor, do not present any additional risk. In addition (although not shown in the photographs) there are unsealed joints around the service entry points, and, because of the form of construction, potential harbourage within the wall structure, although no current infestation.

## LIST OF RELEVANT MATTERS

LIKELIHOOD & OUTCOMES		A		A	
<i>a</i>	Internal walls and ceilings	-	<i>n</i>	Water seals	-
<i>b</i>	External walls and roof	-	<i>o</i>	Disrepair to drains	-
<i>c</i>	Ventilators	-	<i>p</i>	Open vent pipes	-
<i>d</i>	Solid floors	3	<i>q</i>	Design deficiencies	3
<i>e</i>	Suspended floors	-	<i>r</i>	Internal refuse areas	-
<i>f</i>	Under floor space	-	<i>s</i>	External refuse areas	-
<i>g</i>	Roof space	-	<i>t</i>	refuse chutes	-
<i>h</i>	Skirting and architraves	-			
<i>l</i>	Windows and doors	-	<b># Secondary hazards</b>		
<i>j</i>	Window and door frames	-	None		-
<i>k</i>	Ducts and pipework	-			
<i>l</i>	Access to ducts	-	<b>Key</b>		
<i>m</i>	Service entry points	3	3	Seriously defective	1 Not satisfactory
			2	Defective	- Satisfactory/NA

**HEALTH AND SAFETY RATING SYSTEM SCORES**

1946-79 House

LIKELIHOOD Low → High

1 in 1

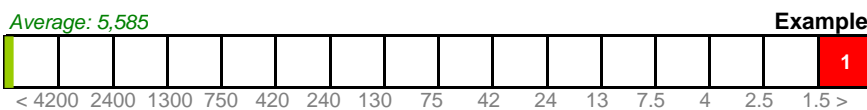

**Justification** The extent of the hazard fault and its location increases the likelihood of a major occurrence significantly above that for the average for this hazard. The possibility of the spillage of food and the dampness, together with the difficulties of cleaning, increase the likelihood of the harborage of insects, cockroaches etc, and the risk of infection, particularly to young children. The joints around service entry points will allow access for pests, and the wall structure will also provide harbourage.

**OUTCOMES**

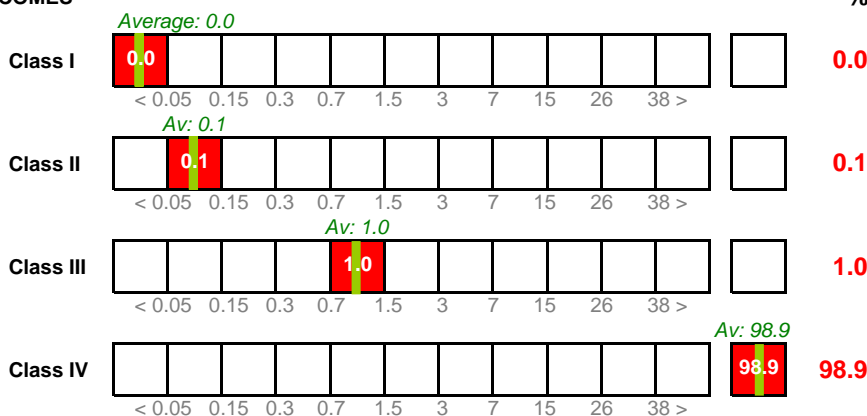

**Justification** Although, for the reasons stated above, the likelihood of a major infection occurring is much higher than the average for this category of hazard, there is unlikely to be any significant change in the spread of health outcomes.



**RATING SCORES AFTER IMPROVEMENT**

**IMPROVE** Likelihood to 1 in 56 **Outcomes to** 0 | 0.1 | 1.0 | 90 %

**Justification** The original thermoplastic tiles should be removed and the floor sealed to prevent further rising damp. An appropriate impervious finish should be provided. In addition, the joints around the service entry points should be effectively sealed. However, because of the type of construction, it would not be practicable to seal all the entry points or remove the harbourage in the wall structure.



Av: Nos Average likelihood, outcomes and HHSRS score for hazards associated with domestic hygiene, pests etc for all persons in all dwellings, 1995-96

## DOMESTIC HYGIENE (REFUSE)

HHSRS V. 2

<b>Vulnerable age</b>	All ages	<b>Multiple locations</b>	Yes	No
<b>Related hazards</b>	Sanitation, Food Safety	<b>Secondary hazards</b>	Yes	No

A) Refuse tower



A) Entrance to bin store



### DESCRIPTION OF HAZARDS

**Dwelling:** Maisonette on 3rd and 4th floors of 1970s block

**Background:** The dwelling is an end maisonette on the third and fourth floor of a nine storey slab block of purpose built flats on a large estate, constructed in the mid 1970s using large panel prefabricated concrete.

**A)**

**Refuse provision:** Refuse disposal points are sited at the end of the block on every other (odd) floor. These consist of a hopper giving access to a chute which discharges into palladins in the refuse store on the ground floor (see photograph). The hopper on the third floor (used by this maisonette) is broken and has fallen out of the access point. The chute is blocked which has led to refuse building-up inside the chute and refuse being left around the disposal point. The doors to the refuse store on the ground floor are missing and the refuse has accumulated on the floor. Dogs, cats, rats, cockroaches and birds have been seen in the refuse store and around the refuse disposal points. The accumulations are also attracting flies during the warm weather.

### LIST OF RELEVANT MATTERS

LIKELIHOOD & OUTCOMES	A			A
<i>a</i> Internal walls and ceilings	-	<i>n</i> Water seals	-	-
<i>b</i> External walls and roof	-	<i>o</i> Disrepair to drains	-	-
<i>c</i> Ventilators	-	<i>p</i> Open vent pipes	-	-
<i>d</i> Solid floors	-	<i>q</i> Design deficiencies	3	-
<i>e</i> Suspended floors	-	<i>r</i> Internal refuse areas	-	-
<i>f</i> Under floor space	-	<i>s</i> External refuse areas	3	-
<i>g</i> Roof space	-	<i>t</i> refuse chutes	3	-
<i>h</i> Skirting and architraves	-			
<i>i</i> Windows and doors	-	<b># Secondary hazards</b>		
<i>j</i> Window and door frames	-	None	-	-
<i>k</i> Ducts and pipework	2			
<i>l</i> Access to ducts	2	<b>Key</b>		
<i>m</i> Service entry points	1	3 Seriously defective	1 Not satisfactory	
		2 Defective	- Satisfactory/NA	

**HEALTH AND SAFETY RATING SYSTEM SCORES**

1946-79 Purpose-built Flat

LIKELIHOOD Low → High

1 in 2

Average: 5,585

Example

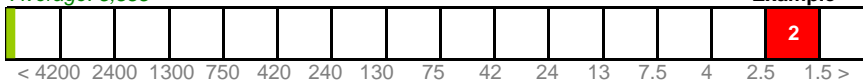

**Justification** The rotting refuse is attracting pests and providing a breeding ground for flies, cockroaches and rats. Children can easily gain access to the refuse disposal points and store. Also the design of the block with many ducts and voids will allow the infestation to spread easily. This all means that the likelihood, over the next twelve months, of an occurrence associated with this dwelling (and other dwellings on this and other floors) is substantially higher than the average.

**OUTCOMES**

%

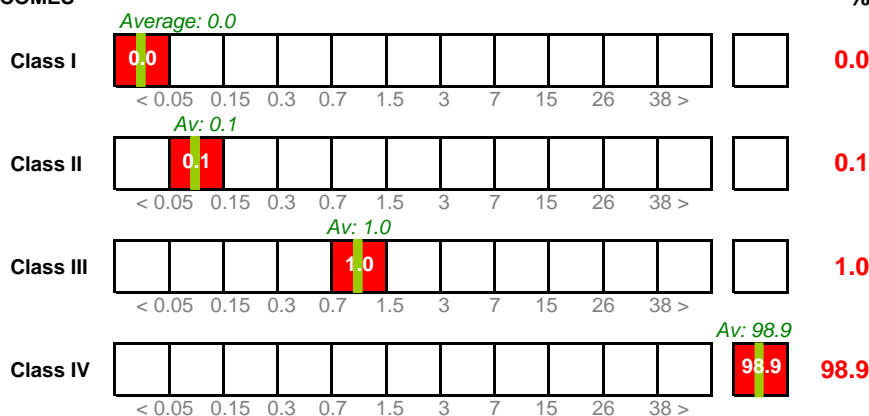

**Justification** There is nothing to indicate that the outcomes from an occurrence will be other than the average.

Example

Average: <1

RATING



Score 694

**RATING SCORES AFTER IMPROVEMENT**

IMPROVE Likelihood to 1 in 100 Outcomes to 0 | 100 | 0 | 0 %

**Justification** The chute should be cleared and thoroughly cleansed. The accumulations removed from the refuse disposal point and store. The hopper and access point repaired or renewed. The doors to the refuse store renewed so they can be effectively locked. There should be proper pest control treatment and, although a management issue, there should also be more frequent refuse collection.

Improved Av: <1

NEW RATING



Score 13

Av: Nos Average likelihood, outcomes and HHSRS score for hazards associated with the storage and disposal of household waste for all persons in all dwellings, 1995-96



# FOOD SAFETY

HHSRS VERSION 2

<b>Vulnerable age</b>	All ages	<b>Multiple locations</b>	Yes	<b>No</b>
<b>Related hazards</b>	Hot surfaces, Fire, Electrical hazards	<b>Secondary hazards</b>	Yes	<b>No</b>

A) Kitchen worktop



A) Floor plan

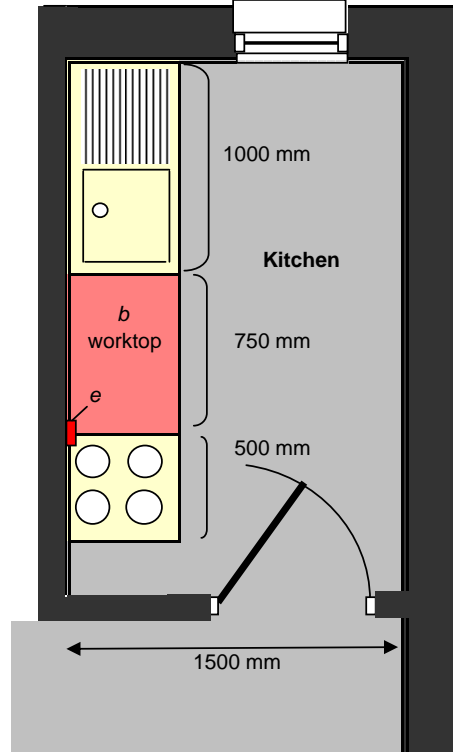

## DESCRIPTION OF HAZARDS

**Dwelling:** Pre 1920, semi-detached house

**Background:** Narrow kitchen: The small kitchen is 2.5 m long by 1.5 m wide. Arranged at one end of one of the longer walls is a 1000 x 500 mm, single drainer sink above a sink unit, with a drawer and cupboards below, and a 500 x 500 mm freestanding gas cooker at the other end.

A)

**Kitchen worktop:** A worktop is provided by a crudely cut and bowed 750 x 500 mm sheet of strawboard spanning between the sink and cooker. Other than the cupboards and drawer under the sink, there are no provisions for the storage of food or kitchen equipment. Provision for a small refrigerator under the worktop is given by the single socket in the wall above the edge of the cooker, but this is the one and only electrical power outlet in the kitchen. This would also put the refrigerator close to the existing, poorly insulated cooker.

## LIST OF RELEVANT MATTERS

### LIKELIHOOD & OUTCOMES

	A		A
<i>a</i> Food storage facilities	3	<i>l</i> Disrepair to cooking facilities	-
<i>b</i> Impervious surfaces	3	<i>m</i> Space for cooking facilities	-
<i>c</i> Disrepair to storage facilities	1	<i>n</i> Kitchen floor	-
<i>d</i> Space for fridge and freezer	1	<i>o</i> Walls and ceilings	-
<i>e</i> Power sockets	3	<i>p</i> Impervious finishes	1
<i>f</i> Sink provision	-	<i>q</i> Defective seal	-
<i>g</i> Drainer to sink	-	<i>r</i> Kitchen lighting	-
<i>h</i> Kitchen worktops	2	<i>s</i> Ventilation	1
<i>l</i> Disrepair	3		
<i>j</i> Provision for cooking	-	<b>Key</b> 3 Seriously defective	1 Not satisfactory
<i>k</i> Size of cooking facilities	-	2 Defective	- Satisfactory/NA

**HEALTH AND SAFETY RATING SYSTEM SCORES**

Pre 1920 House

LIKELIHOOD Low → High

1 in 2

Average: 3.590

Example

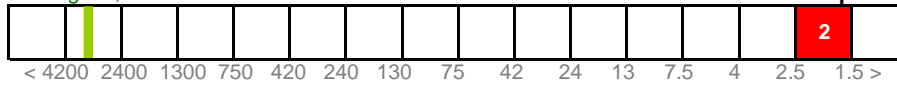

**Justification** The unstable worktop is not of a sufficient area to accommodate the normal range of kitchen equipment and ensure the separation of cooked and uncooked foods. The latter fault is heightened by its porous surface and poor cleanability. With only one socket available the chances of any refrigerator being accidentally left disconnected is also increased. Overall, the risk of food poisoning over the next twelve months is extremely likely.

**OUTCOMES**

%

Average: 0.0

Class I

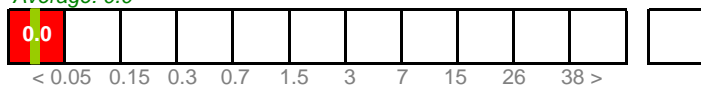

0.0

Av: 2.0

Class II

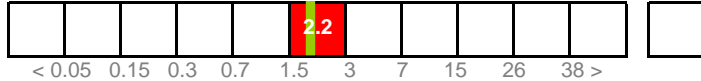

2.2

Av: 22.0

Class III

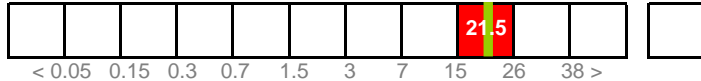

21.5

Av: 76.0

Class IV

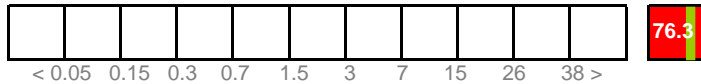

76.3

**Justification** Although the small size and poor facilities of the kitchen substantially increases the risk of food poisoning occurring in this dwelling, the health outcome from any such outbreak remain average.



Score 4706

**RATING SCORES AFTER IMPROVEMENT**

IMPROVE Likelihood to 1 in 320 Outcomes to 0.0 | 2.2 | 21.5 | 76.3 %

**Justification** Improving the facilities for the preparation and cooking of food could be achieved by resiting the sink under the window and the cooker half way along the side wall, leaving space for properly designed units with impervious worktops either side of the cooker. Additional electric socket outlets should also be provided.



Score 29

Av: Nos Average likelihood, outcomes and HHSRS score for hazards associated with food safety for all persons in pre 1920 dwellings not in multiple occupation, 1997-99

# FOOD SAFETY

HHSRS VERSION 2

<b>Vulnerable age</b>	All ages	<b>Multiple locations</b>	Yes	<b>No</b>
<b>Related hazards</b>	Hot surfaces, Fire, Electrical hazards	<b>Secondary hazards</b>	Yes	<b>No</b>

**A) Kitchen sink and shelf**



**Rear elevation**

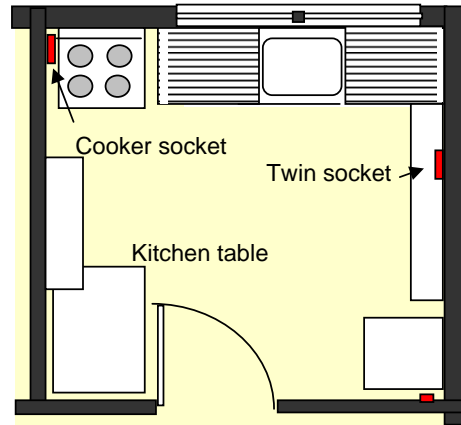

**DESCRIPTION OF HAZARDS**

**Dwelling:** 2 bedroomed 1960s purpose-built flat

**Background:** This is a second floor, 2 bedroomed flat in a block with balcony access built in the late 1960s. The kitchen is located behind a small private balcony.

**Kitchen amenities:** The small kitchen measures 2.4 wide by 2.2 metres in depth. A Belfast sink, that is cracked, chipped and crazed, is supported by wall brackets and metal front legs, is positioned under the centre of the window. The sink is supplied with hot and cold water and has worn and scoured wooden drainers on either side. Located adjacent to the left hand draining board is a freestanding electric cooker. The space for the refrigerator is located in the opposite corner. There is a worktop high 300mm deep shelf along one side wall and a low kitchen table. A 1000mm wide wall unit on the other side wall is the only storage unit provided.

**LIST OF RELEVANT MATTERS**

**LIKELIHOOD & OUTCOMES**

<b>a</b>	Food storage facilities	-	<b>l</b>	Disrepair to cooking facilities	-
<b>b</b>	Impervious surfaces	3	<b>m</b>	Space for cooking facilities	-
<b>c</b>	Disrepair to storage facilities	-	<b>n</b>	Kitchen floor	-
<b>d</b>	Space for fridge and freezer	-	<b>o</b>	Walls and ceilings	-
<b>e</b>	Power sockets	2	<b>p</b>	Impervious finishes	1
<b>f</b>	Sink provision	-	<b>q</b>	Defective seal	-
<b>g</b>	Drainer to sink	3	<b>r</b>	Kitchen lighting	-
<b>h</b>	Kitchen worktops	2	<b>s</b>	Ventilation	-
<b>i</b>	Disrepair	3			
<b>j</b>	Provision for cooking	-	<b>Key</b>	3 Seriously defective	1 Not satisfactory
<b>k</b>	Size of cooking facilities	-		2 Defective	- Satisfactory/NA

**HEALTH AND SAFETY RATING SYSTEM SCORES**

**1946-79 Purpose-built Flat**

**LIKELIHOOD** Low → High

**1 in 10**

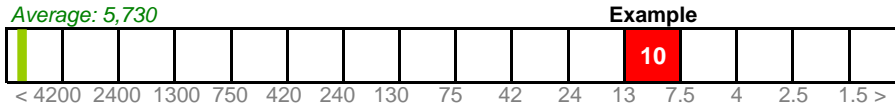

**Justification**

The only impervious work surface at normal worktop height is given by the narrow shelf along the right hand wall of the kitchen. Given the inconvenience of preparing food on this shelf or on the low kitchen table, it is likely that one of the large worn wooden drainers will be used for this purpose and, with its badly worn surface, this could lead to the cross-contamination of cooked and uncooked foods. The lack of proper worktops is further exacerbated by the general lack of storage space in this kitchen.

**OUTCOMES**

**%**

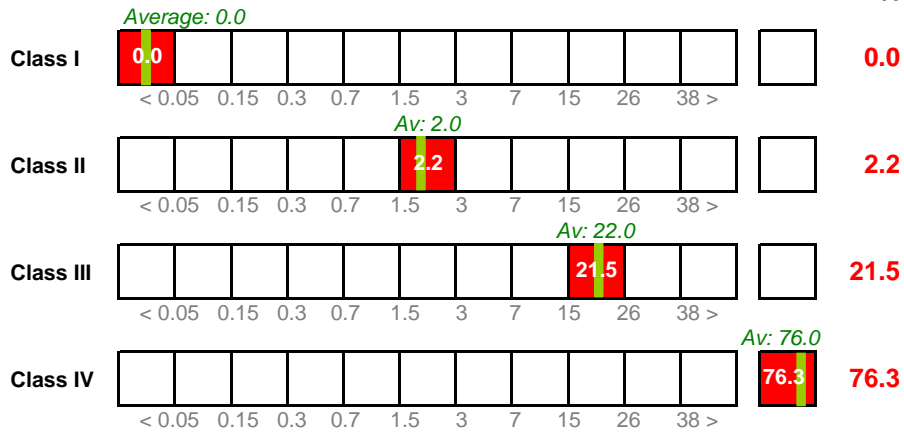

**Justification**

Although the size of the kitchen and poor facilities increases the risk of food poisoning occurring in this dwelling, the health outcomes from any such illness are likely to remain average.

**RATING**



**RATING SCORES AFTER IMPROVEMENT**

**IMPROVE** Likelihood to **1 in 3,200** Outcomes to **0.0 | 2.2 | 21.5 | 76.3 %**

**Justification**

Improving the facilities for the preparation of food and the amount of storage could be achieved by removing the wall cabinet and resiting the cooker near the middle of the adjacent side wall and installing fitted kitchen units with worktops either side. The sink and drainers could also be replaced with a modern sink fitted above a new sink unit providing further storage cupboards below the sink and drainer. This would reduce the rating to average.

**NEW RATING**



*Av: Nos* Average likelihood, outcomes and HHSRS score for hazards associated with food safety for all persons in 1946-79 dwellings not in multiple occupation, 1997-99

# PERSONAL HYGIENE

HHSRS VERSION 2

**Vulnerable age** Persons aged under 5 years  
**Related hazards** Ergonomics

**Multiple locations** Yes No  
**Secondary hazards** Yes No

A) Shower room with w.c.



A) Detail of whb discharge



Front elevation



Rear elevation



## DESCRIPTION OF HAZARDS

**Dwelling:** Ground floor bedsit, in 1910 detached house.

**Background:** This is a large two-storey, Edwardian detached house, converted to four bedsits and one self-contained ground floor flat entered from a separate entrance at the rear. The four bedsits share a kitchen on the ground floor and a single combined shower room and w.c. compartment on the first floor. It is the ground floor front bedsit which is being assessed.

- A) Shower room:** The facilities provided in this room are a w.c, with low level cistern, a wash hand basin and a shower. There is no supply of either hot or cold water to the wash hand basin, this being filled by using the shower head which is detachable and has a flexible hose. There is an electric instantaneous heater serving the shower head. The waste to the basin and overflow to the w.c. cistern both discharge into the shower tray.

## LIST OF RELEVANT MATTERS

### LIKELIHOOD & OUTCOMES

	A			A
<i>a</i> Bath or showers	3	<i>n</i> Effective flush		-
<i>b</i> Wash hand basins	3	<i>o</i> Macerator defects		-
<i>c</i> Hot & cold water supply	-	<i>p</i> Earth closet defects		-
<i>d</i> Kitchen sink	2	<i>q</i> Seat/lid to closet		-
<i>e</i> Clothes drying facilities	2	<i>r</i> Ventilation		-
<i>f</i> Disrepair to facilities	2	<i>s</i> Unhygienic compartment		-
<i>g</i> Inadequate lighting	-	<i>t</i> Inadequate lighting		-
<i>h</i> Shared facilities	3	<i>u</i> Door to compartment		-
<i>i</i> Sewage system	-	<i>v</i> Adjacent washbasin		-
<i>j-k</i> Sanitary provision & siting	-			
<i>l</i> Disrepair of sanitary closet	-	<b>Key</b> 3 Seriously defective	1	Not satisfactory
<i>m</i> Water to wc	-	2 Defective	-	Satisfactory/NA

**HEALTH AND SAFETY RATING SYSTEM SCORES**

Pre 1920 Non s.c. Flat

LIKELIHOOD Low → High

1 in 2

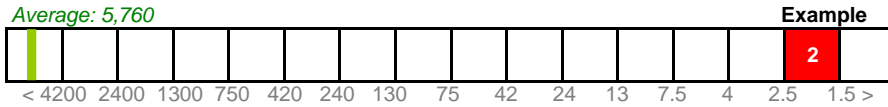

**Justification** The lack of taps to the whb, the location of the basin largely over the shower tray, and the state of the basin all discourage hand washing after using the wc, so significantly increasing the risk of infection. The state of the shower also discourages maintenance of personal hygiene. The room is inconvenient for the ground floor bedsits who may thus use the sink for washing. As all amenities are shared, the risk of spreading infection is increased. Overall, the likelihood of an occurrence is increased substantially for each of the dwellings.

**OUTCOMES**

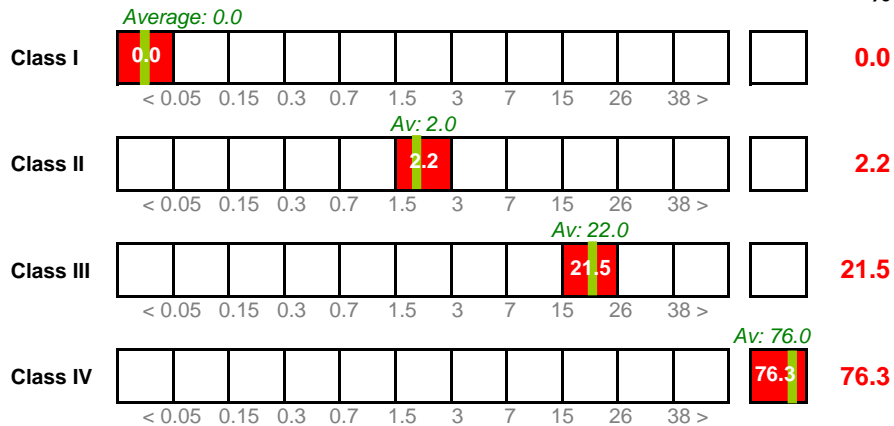

**Justification** Although the inadequate provision for person hygiene in this HMO presents a likelihood of serious infection which is significantly higher than average for all dwellings, the resulting spread of harms is not changed.



**RATING SCORES AFTER IMPROVEMENT**

**IMPROVE** Likelihood to 1 in 320 **Outcomes to** 0 | 2.2 | 21.5 | 76.3 %

**Justification** Resiting the wash hand basin to a more easily accessible location in the shower room and providing it with a separate hot and cold water supply would reduce the likelihood of infection. While facilities are shared, the likelihood will remain above average. (The obvious management problems are outside the scope of the HHSRS.)



Av: Nos Average likelihood, outcomes and HHSRS score for inadequate provision for personal hygiene for persons under 5 years in pre 1920 HMOs & all dwellings.



# SANITATION & DRAINAGE

HHSRS VERSION 2

<b>Vulnerable age</b>	Persons aged under 5 years	<b>Multiple locations</b>	Yes	<b>No</b>
<b>Related hazards</b>	Domestic hygiene	<b>Secondary hazards</b>	Yes	<b>No</b>

A) Detail of joint between waste pipe & soil pipe



Front elevation



A) Rear yard



## DESCRIPTION OF HAZARDS

**Dwelling:** First floor flat in 1900, 3-storey terraced house.

**Background -** The house has been converted into flats. Work is currently in progress to complete the first floor front flat. The four completed flats are self-contained, each with a combined bathroom and wc and separate kitchen.

- A) **Soil pipe:** The soil and vent pipe serving the first floor back addition bathroom is leaking at the joint between the pipe and the waste pipe from the ground floor back addition bathroom. In addition, the drain, which runs directly to the main sewer, appears to be partially blocked causing foul and waste water to back-up and leak out onto the common rear yard.

## LIST OF RELEVANT MATTERS

LIKELIHOOD & OUTCOMES	A	# Secondary hazards	A
a Soil and waste pipe provision	2	- None	-
b Pipe defects	3		
c Traps and water seals	-		
d Ventilation of pipes	-		
e Disrepair to system	3		
f Private sewage systems	-	<b>Key</b>	3 Seriously defective
g Soakaway	-		2 Defective
h Surface water drainage	-		1 Not satisfactory
i Recycling system	-		- Satisfactory/NA

HEALTH AND SAFETY RATING SYSTEM SCORES		Pre 1920 converted s/c Flats	
<b>LIKELIHOOD</b>	Low → High	<b>1 in</b>	<b>6</b>
<p>Average: 5,790</p> <p>Example</p>			
<b>Justification</b>	<p>Although there have been recent works to the house, including alterations and additions to the drainage system, the main drains are still appropriate to a pre-1919 dwelling occupied by a single family. Although the first floor flats are less likely to be affected than the ground floor flats, the discharging of foul water on to the common yard means there is a very high likelihood of an occurrence within the next twelve months.</p>		
<b>OUTCOMES</b>			<b>%</b>
<b>Class I</b>	<p>Average: 0.0</p>		<b>0.0</b>
<b>Class II</b>	<p>Av: 2.0</p>		<b>2.2</b>
<b>Class III</b>	<p>Av: 22.0</p>		<b>21.5</b>
<b>Class IV</b>	<p>Av: 76.0</p>		<b>76.3</b>
<b>Justification</b>	<p>While the likelihood has dramatically increased, there is nothing to suggest the outcomes will have changed from the average.</p>		
<b>RATING</b>	<p>Example</p> <p>Average: 2</p>	<b>Score</b>	<b>1568</b>
<b>RATING SCORES AFTER IMPROVEMENT</b>			
<b>IMPROVE</b>	Likelihood to	<b>1 in 320</b>	Outcomes to <b>0.0   2.2   21.5   76.3 %</b>
<b>Justification</b>	<p>The drains should be cleansed and, if necessary repaired. The joints to the soil and vent pipe and between that pipe and the waste pipe should be properly sealed and made watertight. This will reduce the likelihood but the rating will remain higher than average due to the inadequately sized branch drain leading to the main sewer and the consequent occasional risk of blockage.</p>		
<b>NEW RATING</b>	<p>Improved</p> <p>Av: 2</p>	<b>Score</b>	<b>29</b>
<p>Av: Nos Average likelihood, outcomes and HHSRS score for hazards associated with inadequate sanitation for persons aged under 5 years in pre 1920 HMOs, 1997-99</p>			

## PERSONAL HYGIENE ETC

HHSRS VERSION 2

<b>Vulnerable age</b>	Persons aged under 5 years	<b>Multiple locations</b>	Yes	<b>No</b>
<b>Related hazards</b>	Food safety, domestic hygiene	<b>Secondary hazards</b>	Yes	<b>No</b>

Front north elevation



Ground floor plan of back extension

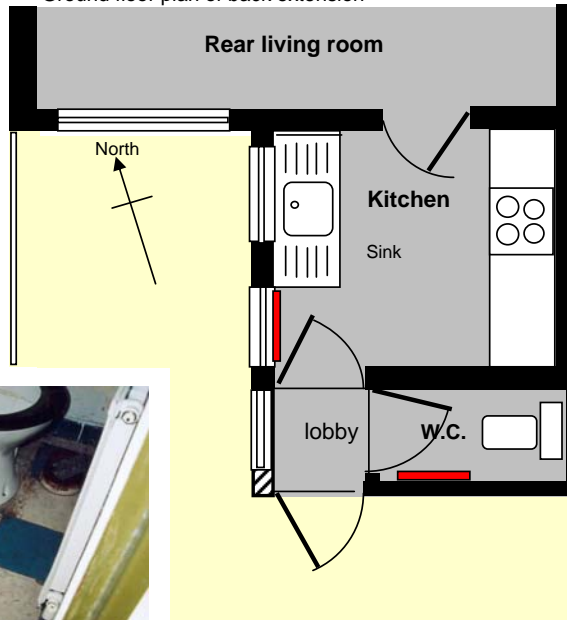

### DESCRIPTION OF HAZARD

3 bedroomed 1850 mid terrace house

**Background** - This 3-bedroomed early Victorian house was modernised in the 1970s. In this modernisation, the original external door to the south facing back addition was made into a window and a new back porch/lobby was constructed to give a new back door and internal access to the original outside w.c. compartment. At the same time, a new bathroom with a bath and wash hand basin, but no w.c., was installed at first floor level in the small back addition above the kitchen. Subsequently, central heating was also installed, including the installation of a radiator in the otherwise cold ground floor w.c. compartment.

**Ground floor w.c.:** Despite the modernisation, the narrow downstairs w.c. compartment was left without a wash-hand basin. Although the compartment's single leaf brick wall was rendered externally, the floor was also never adequately damp-proofed, the consequent rising damp leading to the lifting and subsequent break up of the thermo plastic floor tiles. The lid to the wc is also now missing.

### LIST OF RELEVANT MATTERS

#### LIKELIHOOD & OUTCOMES

##### Sanitation facilities

<i>a</i> Sewage system	-	<b>A</b>
<i>b</i> Sanitary provision	1	
<i>c</i> Sanitary closet siting	3	
<i>d</i> Disrepair of sanitary closet	-	
<i>e</i> Water to wc.	-	
<i>f</i> Effective flush	-	
<i>g</i> Macerator defects	-	
<i>h</i> Earth closet defects	-	
<i>i</i> Seat/lid to sanitary closet	2	
<i>j</i> Ventilation to compartment	2	

<i>k</i> Unhygienic compartment	3	<b>A</b>
<i>l</i> Inadequate lighting	-	
<i>m</i> Door to compartment	-	
<i>n</i> Adjacent wash-hand basin	3	

**# Secondary hazards** **A**  
None

<b>Key</b>	3 Seriously defective	1 Not satisfactory
	2 Defective	- Satisfactory/NA

HEALTH AND SAFETY RATING SYSTEM SCORES		Pre 1920 House
<b>LIKELIHOOD</b>	Low → High	<b>1 in 18</b>
<p><i>Average: 7,040</i> <span style="float: right;"><b>Example</b></span></p> <p>&lt; 4200 2400 1300 750 420 240 130 75 42 24 13 7.5 4 2.5 1.5 &gt;</p>		
<b>Justification</b>	<p>With no wash-hand basin on the ground floor and the upstairs bathroom being the furthest possible walking distance in the house away, anyone using the ground floor w.c., particularly children, are likely to forego washing their hands. The inconvenient location of the w.c. and its extreme separation from the w.h.b. is also likely to have some psychological effects. The related risk of washing hands in the nearby sink is scored under food safety, while the unhygienic floor to the w.c. compartment is scored under domestic hygiene.</p>	
<b>OUTCOMES</b>		<b>%</b>
<b>Class I</b>	<p><i>Average: 0.0</i></p> <p>&lt; 0.05 0.15 0.3 0.7 1.5 3 7 15 26 38 &gt;</p>	<b>0.0</b>
<b>Class II</b>	<p><i>Av: 2.0</i></p> <p>&lt; 0.05 0.15 0.3 0.7 1.5 3 7 15 26 38 &gt;</p>	<b>2.2</b>
<b>Class III</b>	<p><i>Av: 22.0</i></p> <p>&lt; 0.05 0.15 0.3 0.7 1.5 3 7 15 26 38 &gt;</p>	<b>21.5</b>
<b>Class IV</b>	<p><i>Av: 76.0</i></p> <p>&lt; 0.05 0.15 0.3 0.7 1.5 3 7 15 26 38 &gt;</p>	<b>76.3</b>
<b>Justification</b>	<p>While the likelihood of infection is increased, there is nothing to suggest that the outcomes should be changed from the average. However, with the high likelihood this still gives an HHSRS score of 522 and a band rating of D-.</p>	
<b>RATING</b>	<p><b>Example</b> <span style="float: right;"><i>Average: 1</i></span></p>	<b>Score 522</b>
<b>RATING SCORES AFTER IMPROVEMENT</b>		
<b>IMPROVE</b>	<b>Likelihood to</b> 1 in 5,600	<b>Outcomes to</b> 0.0   2.2   21.5   76.3 %
<b>Justification</b>	<p>Ideally, a w.c. needs to be installed in the first floor bathroom, if necessary by replacing the bath with a shower. Alternatively, the existing w.c. compartment could be rebuilt to modern building regulation standards. The new compartment would need to be wide enough to accommodate a new wash hand basin as well as any re-positioned radiator. This would reduce the HHSRS score to average.</p>	
<b>NEW RATING</b>	<p><b>Improved</b></p>	<b>Score 1</b>
<p><i>Av: Nos</i> Average likelihood, outcomes and HHSRS score for hazards associated with inadequate sanitation for persons aged under 5 years in pre 1920 houses, 1997-99</p>		

# WATER CONTAMINATION

HHSRS VERSION 2

**Vulnerable age** All ages  
**Related hazards** None

**Multiple locations** Yes  
**Secondary hazards** Yes **No**  
**No**

Ultra-violet filter



Holiday house



Settlement tanks near stream



Reservoir on stream



## DESCRIPTION OF HAZARDS

**Dwelling:** Detached second homes built in 1970s

- A) Background:** The house, which is used as a second home, is situated in remote woodland in a mountainous area. It is on mains electricity, but has its own private water supply.  
**Private water supply:-** All water to the house comes from a mountain stream running through the grounds, which has been dammed to produce a small shallow reservoir. From an inlet pipe near the dam, the water first runs a short distance to a sunken settlement tank adjacent to the stream, which has three chambers. After passing through these chambers, the water is piped underground to a small pump room adjacent to the house. Here it is pumped through an ultra violet filter and up to a storage tank in the roof of the house. This supplies the kitchen tap, other cold taps, the w.c. and a hot water cylinder.  
 Rodents have chewed through a loose cable in the pump room thereby disabling the operation of the u.v. filter, but leaving the pump to still operate.

## LIST OF RELEVANT MATTERS

LIKELIHOOD & OUTCOMES	A	# Secondary hazards	A
a Water supply tap	-	- None	-
b Intermittent supply	-		
c Water pressure	-		
d Water temperature	-		
e Defective pipework etc	-	<b>Key</b> 3	Seriously defective
f Contamination of tanks	-	2	Defective
g Water filter defects	3	1	Not satisfactory
h Water softening system	-	-	Satisfactory/NA



**HEALTH AND SAFETY RATING SYSTEM SCORES**

1946-79 House

LIKELIHOOD Low → High

1 in 3

Average: 1,700,211

Example

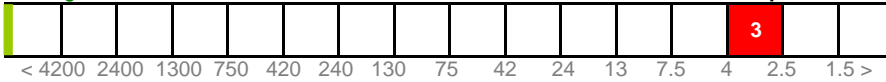

**Justification** As the supply is taken from the stream several miles from its mountain source, it is heavily contaminated by both solid particles and microbiological organisms. While the initial settling beds filter out the solid matter in the stream water, the system relies on the ultra-violet filter to eradicate the microbiological contamination. With this filter out of action, contaminated water is being pumped into the storage tanks and fed to the kitchen and other cold taps. The likelihood of drinking this water and being infected by it is very high.

**OUTCOMES**

%

Average: 0.0



Av: 1.0



Av: 9.0



Av: 90.0



**Justification** Although the likelihood of infection is very high, the spread of health outcomes is average.

Example

Average: <1

RATING



Score 1630

**RATING SCORES AFTER IMPROVEMENT**

**IMPROVE** Likelihood to 1 in 320 Outcomes to 0.0 | 1.0 | 10.0 | 89.0 %

**Justification** Although representing a serious hazard in its present state, restoring the water system to provide potable water would be very quick and inexpensive. All that is required is for the cable to the ultra-violet water filter to be replaced and the pump room to be sealed or the cabling placed in a metal conduit to prevent further attack by rodents. However, due to the nature of the supply and system, some risk is likely to remain.

Improved Av: <1

NEW RATING



Score 15

Av: Nos Average likelihood, outcomes and HHSRS score for hazards from contaminated water for all persons in 1946-79 dwellings not in multiple occupation, 1997-99



# FALLS WITH BATHS ETC

HHSRS Version 2

<b>Vulnerable age</b>	Persons aged 60 years and over	<b>Multiple locations</b>	Yes	<b>No</b>
<b>Related hazards</b>	Structural Collapse etc, Dampness	<b>Secondary hazards</b>	Yes	<b>No</b>

Head of bath



Front elevation



Rear elevation



Bath legs at head



Bath legs at foot



## DESCRIPTION OF HAZARDS

**Dwelling:** 1920-45 semi-detached house

**A) Background:** This is a four bedroomed inter-war semi-detached house which has a centrally located bathroom with a window in the flank wall. The house, including the bathroom, has been the subject of DIY modernisation over the years, but all works have been done to a low standard.

**Bath:** To provide a level footing for the four feet of the bath, old white shelving has been placed over the old uneven floor boards. However, no fixing has been provided and with the use of the bath, the boards have now shifted and the feet become dislodged, causing the bath to be unstable and liable to rock. The bath itself has a narrow rim, no grab rails and a rounded bottom with no patterning to increase friction. Elsewhere on the bathroom floor, plywood has been laid over the uneven boards and varnished, and now covered with loose rugs.

## LIST OF RELEVANT MATTERS

LIKELIHOOD	A	OUTCOMES	A
a Poor friction	3	a Projections	-
b Siting of taps, wastes etc	-	b Inadequate space	-
c Handles and grab rails	3	c Space heating	-
d Unstable appliance	3		
e Inadequate space	-	<b># Secondary hazard</b>	
f Inadequate lighting	-	None	-
g Glare	-		
h Space heating	-		
		<b>Key</b>	
		3	Seriously defective
		2	Defective
		1	Not satisfactory
		-	Satisfactory/NA

**HEALTH AND SAFETY RATING SYSTEM SCORES**

1920-45 House

LIKELIHOOD Low → High

1 in 32

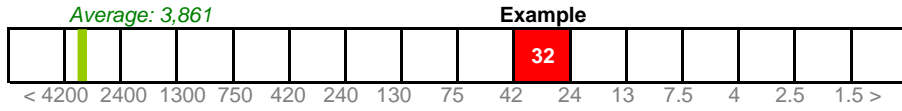

**Justification** The risk of a fall associated with the bath is substantially increased by the fact that it is no longer stable and liable to rock significantly as a person gets in and out of the bath. The risk is further exacerbated by the old fashioned design of the bath, with its deep rounded bottom and lack of surface friction, narrow rim and lack of any grab handles. There is also a danger of slipping on the varnished floor, even discounting the loose rugs, when getting in or out of the bath.

**OUTCOMES**

%

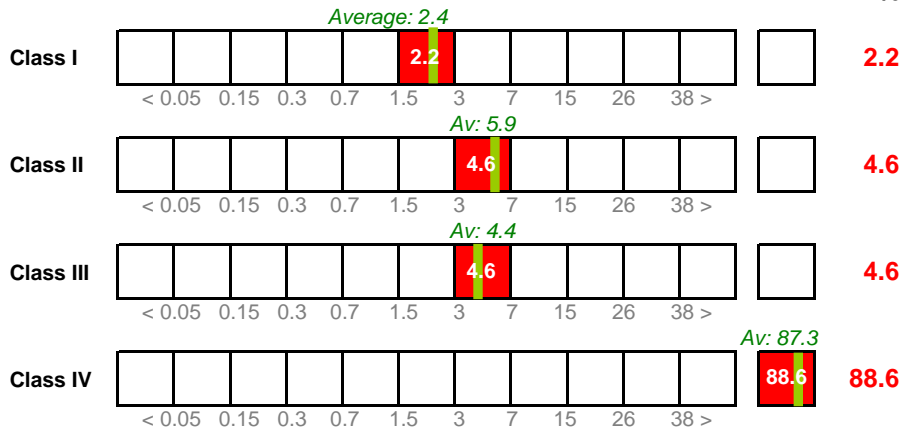

**Justification** Although the likelihood of a fall associated with the bath is significantly higher than average, the health outcomes are judged to be average as there are no secondary hazards or other additional compounding matters in the bathroom to suggest that the scores should be increased. However, with the high likelihood the resulting HHSRS rating is band D.



**RATING SCORES AFTER IMPROVEMENT**

**IMPROVE** Likelihood to 1 in 5,600 Outcomes to 2.2 | 4.6 | 4.6 | 88.6 %

**Justification** The floor beneath the bath needs to be made level, either by replacing the old boards or by covering with suitable plywood sheeting. Making the bath fully stable by providing new fully fixed bath supports would reduce the likelihood significantly. However, replacing the bath with one with a flat textured non-slip bottom and grab handles either side, or on the wall above the bath, would reduce the score to better than average for this age of dwelling.



Av: Nos Average likelihood, outcomes and HHSRS score for hazards for falls associated with baths for persons aged 60 years or over in 1920-45 houses, 1997-99

# FALLS ON THE LEVEL

HHSRS VERSION 2

**Vulnerable group** Persons aged 60 years or over  
**Related hazards** None

**Multiple locations** Yes No  
**Secondary hazards** Yes No

A) Front yard

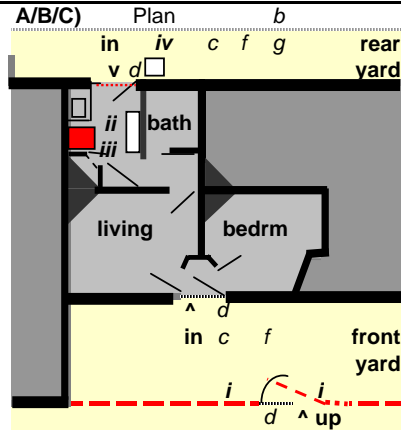

B) Rear door



C) Rear yard



## DESCRIPTION OF HAZARD/S

**Dwelling:** c.1880, Mid-terraced, former almshouse

**A) Front yard:** Access to the front door is via a gate and step, and across the common yard. This has no artificial lighting despite being located on a poorly lit road. The yard surface is uneven stone slabs and brick paving. The spiked iron railings and spiked front gate are about 600 mm high.

**B) Rear door:** The rear access door has a threshold, which rises about 160mm above the kitchen floor and 200mm above the rear yard surface. A cooker and folding worktop are under a metre away.

**C) Rear yard:** Access to the rear door is via a side gate and along the common rear yard, which is lit only by individual outside lights to each dwelling. The yard surface is tarmac. It has a central drainage channel and is cracked and distorted and tends to hold water in places.

## LIST OF RELEVANT MATTERS

LIKELIHOOD	A	B	C	OUTCOMES	A	B	C
a Lack of floor surface	-	-	-	a Hard surfaces	2	1	2
b Excessive slope	-	-	1	b Projections etc #	3	3	1
c Uneven surface	3	-	2	c Nature of area	-	1	1
d Trip steps/threshold	-	3	-	d Thermal efficiency	2	1	3
e Disrepair	2	1	2				
f Poor slip resistance	3	-	1	<b># Secondary hazards</b>	<b>A</b>	<b>B</b>	<b>C</b>
g Inadequate drainage	-	-	1	i Cooker	-	3	-
h Inadequate space	-	3	-	ii Folding worktop	-	2	-
i Poor lighting or glare	3	-	2				
j Thermal efficiency	2	-	3				

**Key** 3 Seriously defective 2 Defective 1 Not satisfactory - Satisfactory/NA

**HEALTH AND SAFETY RATING SYSTEM SCORES**

Pre 1920 House

LIKELIHOOD Low → High

1 in 18

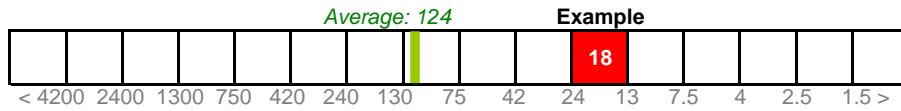

**Justification** The small rooms and provision of grabrails reduce the likelihood of a fall inside this dwelling to better than average for its age. However, the largely unlit access to both the front and rear doors - the uneven stone and brick paved courtyard at the front, which is likely to be slippery in wet or icy weather, and the unexpected threshold at the rear door and the uneven, cracked and, in places, poorly drained rear yard - is likely to increase this risk substantially.

**OUTCOMES**

%

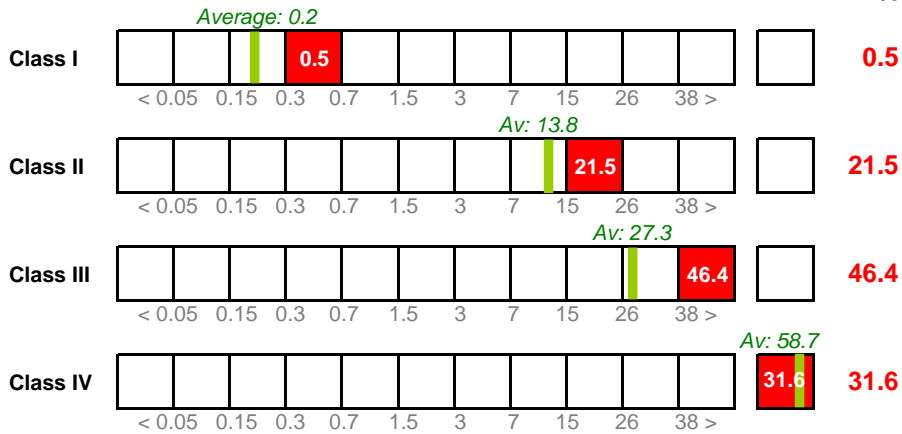

**Justification** The chance of suffering a fatal, severe or serious accident is significantly higher than average because of the hard surfaces, secondary hazards and other compounding matters. These are the low spiked iron railings and gate in the front access courtyard. The cooker and folding worktop in the very small kitchen, which are hazards in their own right, are less than one metre away from the back door trip step and so in the possible line of a fall.

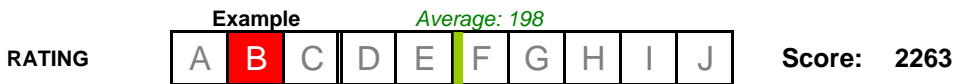

**RATING SCORES AFTER IMPROVEMENT**

**IMPROVE** Likelihood to 1 in 180 Outcomes to 0.2 | 21.5 | 46.4 | 31.9 %

**Justification** Relaying the front and rear yards and replacing the front railings and gate with higher, less dangerous ones, while also providing a normal threshold to the rear door could, with better lighting, substantially reduce the likelihood of a fall. However, the kitchen is too small to change and even after improvement, the spread of harms will remain high.

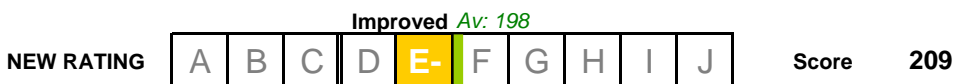

Av: Nos Average likelihood, outcomes and HHSRS score for falls on level by persons aged 60 years or more in and around pre-1920 houses, 1997-99.

# FALLS ON THE LEVEL

HHSRS VERSION 2

<b>Vulnerable group</b>	Persons aged 60 years or over	<b>Multiple locations</b>	Yes	No
<b>Related hazards</b>	None	<b>Secondary hazards</b>	Yes	No

A) Steps to patio and back door



A) Rear yard



B) Ground floor rooms



Elevation



## DESCRIPTION OF HAZARD/S

**Dwelling:** Pre 1920, mid terraced, 3 bedroomed house

- A) Rear steps:** The kitchen door in the back addition and patio doors to the main rear room both open outwards onto the concrete yard. They open awkwardly over respectively a single grey brick and concrete step/threshold. The patio door is fitted with safety glass.
- B) Floor surfaces:** The floor surfaces in the main rooms on the ground floor, including the area at the foot of the stairs, comprise highly varnished stripped wooden floor boards. There are also some loose boards. The rest of the flooring in the house is typical of the dwelling age and type.
- C) Rear garden:** The rear garden beyond the patio/yard has a surface of rough cast and broken concrete.

## LIST OF RELEVANT MATTERS

LIKELIHOOD	A	B	C	OUTCOMES	A	B	C
<i>a</i> Lack of floor surface	-	-	-	<i>a</i> Hard surfaces	3	1	3
<i>b</i> Excessive slope	-	-	-	<i>b</i> Projections etc	-	-	-
<i>c</i> Uneven surface	-	1	-	<i>c</i> Nature of area	-	-	-
<i>d</i> Trip steps/threshold	3	-	-	<i>d</i> Thermal efficiency	1	-	1
<i>e</i> Disrepair	-	2	-				
<i>f</i> Poor slip resistance	1	3	-	<b># Secondary hazards</b>	<b>A</b>	<b>B</b>	<b>C</b>
<i>g</i> Inadequate drainage	-	-	-	- None	-	-	-
<i>h</i> Inadequate space	-	-	-				
<i>i</i> Poor lighting or glare	1	1	-				
<i>j</i> Thermal efficiency	1	-	1				
<b>Key</b>	3	2	1	3 Seriously defective	2 Defective	1 Not satisfactory	- Satisfactory/NA

**HEALTH AND SAFETY RATING SYSTEM SCORES**

Pre 1920 House

LIKELIHOOD Low → High

1 in 32

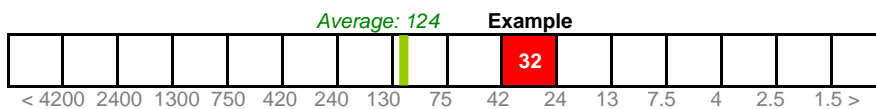

**Justification** The way the rear doors open over the threshold and the poor differentiation between the colour of this step and patio surface increase the risk of a fall when exiting to the rear. The loose boards also increase the risk and are a matter for the HHSRS. Although the floors were originally designed to be carpeted, the work to expose and varnish the floors represents a material change to the dwelling and their consequent slippiness an added hazard. The rear garden surface presents another small risk.

**OUTCOMES**

%

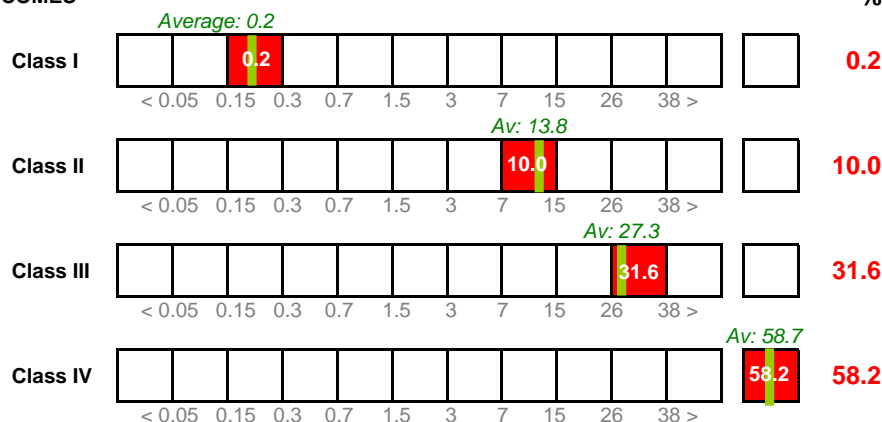

**Justification** Although the likelihood of a fall is higher than average, there are no secondary hazards or other atypical features to increase the spread of harms significantly above the average for this age and type of dwelling.

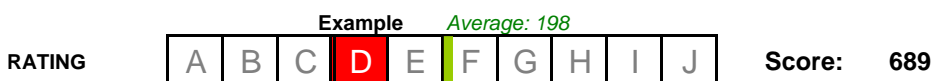

**RATING SCORES AFTER IMPROVEMENT**

**IMPROVE** Likelihood to 1 in 100 Outcomes to 0.2 | 10.0 | 31.6 | 58.2 %

**Justification** Providing a wide level platform outside the kitchen and patio doors, repairing and re-carpeting or re-finishing the floor boards to give a less highly glazed, slippery finish and grassing the rear garden would reduce the likelihood of a fall to the average for this age of dwelling.

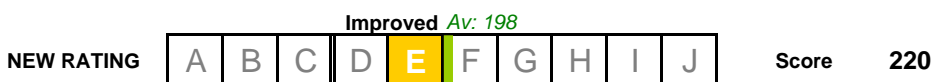

*Av: Nos* Average likelihood, outcomes and HHSRS score for falls on level by persons aged 60 years or more in and around pre-1920 houses, 1997-99.







# FALLS ON THE LEVEL

HHSRS VERSION 2

<b>Vulnerable group</b>	Persons aged 60 years or over	<b>Multiple locations</b>	<b>Yes</b>	No
<b>Related hazards</b>	None	<b>Secondary hazards</b>	<b>Yes</b>	No

A) Front entrance steps



Front elevation



Rear elevation



C) Drain cover



B) Patio door

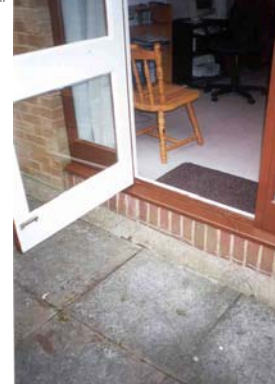

C) Path to rear



**DESCRIPTION OF HAZARD/S**

**Dwelling:**

1980's, 3 bedroomed house

- A) Front entrance steps:** The two concrete paving slabs forming the main entrance steps from the brick paved common parking area to the front porch are sloping and very unevenly laid. In front of the steps there are low brick walls forming an entrance and the two sides of the open porch.
- B) Patio door:** The patio door has a 250 mm high threshold step and is outward opening. The door has two large areas of glazing, both fitted with safety glass.
- C) Path to rear:** A path of concrete slabs leads from the front, around the side and rear of the dwelling to the patio area. A drop at the angle of the front and side sections is unguarded. The partially covered rear section is particularly uneven and includes a raised drainage cover.

**LIST OF RELEVANT MATTERS**

LIKELIHOOD	A	B	C	OUTCOMES	A	B	C
<i>a</i> Lack of floor surface	-	-	-	<i>a</i> Hard surfaces	2	2	2
<i>b</i> Excessive slope	2	-	-	<i>b</i> Projections etc	3	1	3
<i>c</i> Uneven surface	3	-	3	<i>c</i> Nature of area	1	1	-
<i>d</i> Trip steps/threshold	2	2	-	<i>d</i> Thermal efficiency	1	1	-
<i>e</i> Disrepair	3	-	-				
<i>f</i> Poor slip resistance	1	-	1	<b># Secondary hazards</b>	<b>A</b>	<b>B</b>	<b>C</b>
<i>g</i> Inadequate drainage	1	-	1	<i>i</i> Brick guarding	3	-	-
<i>h</i> Inadequate space	-	-	-	<i>ii</i> Glass door	-	-	-
<i>i</i> Poor lighting or glare	2	1	3	<i>iii</i> Water tap	-	-	2
<i>j</i> Thermal efficiency	-	-	-				
<b>Key</b>	3	2	1	Not satisfactory	-	Satisfactory/NA	

**HEALTH AND SAFETY RATING SYSTEM SCORES**

Post 1979 House

LIKELIHOOD Low → High

1 in 100

Average: 126 Example

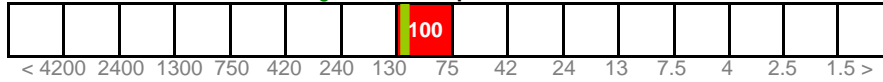

**Justification** The uneven steps to the front porch, the height of the threshold to the rear patio door and the way this opens outward, all increase the risk of a fall when entering or exiting the dwelling. Although probably used less, the lack of guarding, unevenness and projecting drainage cover encountered on the side and rear pathway, also increase the likelihood of a fall somewhat above average for houses built in 1980 and after.

**OUTCOMES**

%

Average: 0.1

Class I



0.1

Av: 13.8

Class II



21.5

Av: 33.9

Class III



31.6

Av: 52.2

Class IV



46.8

**Justification** The risk of a severe accident is increased by the prevalence of hard surfaces and sharp edges around the dwelling and the secondary hazards, particularly, the low brick walls to the porch which are in the possible line of a fall from the front steps and the projecting water tap in the rear wall close to the raised drainage cover.

Example Average: 201

RATING



Score 324

**RATING SCORES AFTER IMPROVEMENT**

IMPROVE Likelihood to 1 in 180 Outcomes to 0.1 | 21.5 | 31.6 | 46.8 %

**Justification** Providing new front steps and having a wide level platform outside the patio doors, would reduce the likelihood of a fall, as would extending the side fence at the front, lowering the raised drainage cover and relaying the paving slabs along the side and rear path. However, with no change to the porch, the spread of harms would remain similar.

Av: 236 Example

NEW RATING



Score 180

Av: Nos Average likelihood, outcomes and HHSRS score for falls on level by persons aged 60 years or more in and around post-1979 houses, 1997-99.

# FALLS ON THE LEVEL

HHSRS VERSION 2

<b>Vulnerable group</b>	Persons aged 60 years or over	<b>Multiple locations</b>	Yes	<b>No</b>
<b>Related hazards</b>	Food safety, Damp	<b>Secondary hazards</b>	Yes	No

A) Kitchen floor



Front elevation



A) Plan

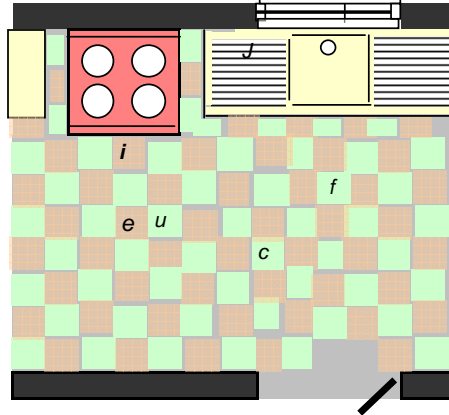

**DESCRIPTION OF HAZARD/S** Dwelling: Early 1960's, semi-detached non-trad house

**A) Kitchen floor:** The main photograph shows the kitchen floor looking through the main door leading from the other rooms in the dwelling. Throughout the kitchen, the original thermoplastic plastic tiles have become unstuck due to rising damp through the concrete sub-floor and have also become brittle and broken with age. The remaining floors in the dwelling, although similarly damp on the ground floor, do not present any additional risk with respect to falls on the level and the front access and rear paths are also in reasonable condition. (This floor would also need to be separately rated with respect to provision for food safety)

## LIST OF RELEVANT MATTERS

LIKELIHOOD	A	OUTCOMES	A
a Lack of floor surface	-	a Hard surfaces #	2
b Excessive slope	-	b Projections etc	3
c Uneven surface	3	c Nature of area	2
d Trip steps/threshold	-	d Thermal efficiency	1
e Disrepair	3		
f Poor slip resistance	2	<b># Secondary hazards</b>	<b>A</b>
g Inadequate drainage	-	i Cooker	3
h Inadequate space	-		
i Poor lighting or glare	1		
j Thermal efficiency	1		

**Key** 3 Seriously defective 2 Defective 1 Not satisfactory - Satisfactory/NA





# FALLS ON STAIRS ETC

HHSRS VERSION 2

<b>Vulnerable group</b>	Persons aged 60 years or over	<b>Multiple locations</b>	Yes	No
<b>Related hazards</b>	None	<b>Secondary hazards</b>	Yes	No

A) Front door steps



A/B) Plan

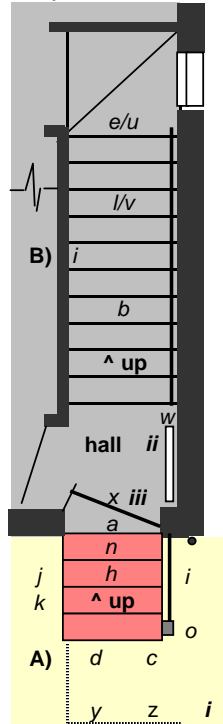

B) Main stairs



C) Steps at gate



## DESCRIPTION OF HAZARD/S

Dwelling: 1930s, Semi-detached house

- A) Front door steps:** These are of smooth painted concrete and have no top 'landing'. The bottom riser is high and uneven (300 mm max). There is a wobbly tubular steel handrail on one side but no guarding at all, despite the narrow width. There is no external porch light and little street lighting.
- B) Main stair:** The main internal stairs have two winders at the top and are moderately steep. There is a handrail only along the outside wall of the straight flight. There is a projecting radiator in the small hall and some glass in the front door close to the foot of the stairs.
- C) Steps at gate:** The steps close to the front gate are of rough spalling concrete. They have high uneven risers and a narrow tread. There is a crude rotten timber handrail but no guarding.

## LIST OF RELEVANT MATTERS

LIKELIHOOD	A	B	C	OUTCOMES	A	B	C
a Tread lengths	1	1	2	a Length of flight	-	1	-
b Riser heights	3	1	2	b Pitch of stairs	-	2	-
c Variation in T&Rs	3	1	2	c Projections etc #	-	2	3
d Nosing length	-	-	-	d Hard surfaces #	2	1	2
e Poor friction quality	3	-	1	e Construction/repair	2	-	3
f Openings - in stairs	-	-	-	f Thermal efficiency	3	-	2
g Alternating treads	-	-	-				
h-i Lack/height handrails	3	2	2	<b># Secondary hazards</b>	<b>A</b>	<b>B</b>	<b>C</b>
j-l Lack/height guarding	3	-	1	i Concrete kerb	2	-	-
m Stair width	2	-	-	ii Projecting radiator	-	2	-
n Length of flight	-	1	-	iii Glass in front door	-	1	-
o-q Inadequate lighting etc	3	-	3	iv Condition of paths	3	-	2
r Door/s onto stairs	-	-	-				
s Inadequate landing	3	-	-	<b>Key</b>	3	1	Not satisfactory
t Construction/repair	2	-	3		2	-	Satisfactory/NA
u Thermal efficiency	2	-	1				

**HEALTH AND SAFETY RATING SYSTEM SCORES**

1920-45 House

LIKELIHOOD Low → High

1 in 18

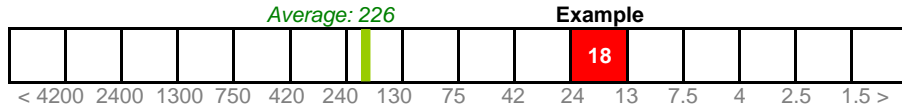

**Justification** The main stairs are assessed as giving the same likelihood of a major fall as the average for inter-war houses, (i.e. around 1 in 230), the limited handrail provision cancelling out any benefits of the broad winders. However, the added presence of the front access steps - particularly dangerous in icy weather and at night - substantially increases the overall annual probability of such a fall - to between 1 in 24 and 1 in 13.

**OUTCOMES**

%

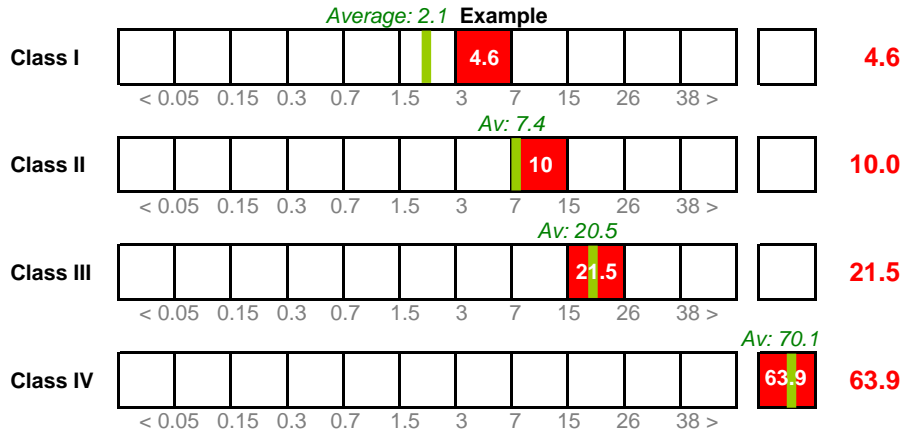

**Justification** The stairs are designed to be carpeted but the resulting lower harms are offset by the small hall, projecting radiator and single glazing in the door, albeit this is not at low level. However, the presence of the external front door steps and steps near the front gate, both flanked by rough tarmac and a concrete kerb, significantly increase the risk of a fatal or severe fall occurring, particularly in cold weather or at night.

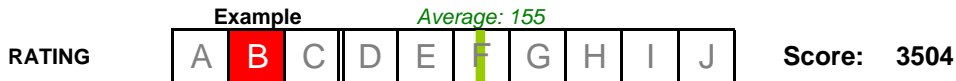

**RATING SCORES AFTER IMPROVEMENT**

IMPROVE Likelihood to 1 in 180 Outcomes to 2.2 | 10.0 | 21.5 | 66.3 %

**Justification** Replacing the steps to the front door and at the gate with steps satisfying current Building Regulations and British Standards and fitting a porch light and a full handrail on both sides of the main stair would give a more average likelihood of a major fall and an average spread of health outcomes, and thereby a rating closer to the average.

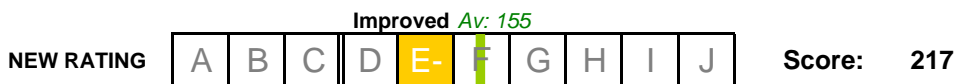

Av Nos: Average likelihood, outcomes and HHSRS score for falls on stairs and steps by persons aged 60 years or more in and around 1920-45 houses, 1997-99.

# FALLS ON STAIRS ETC

HHSRS VERSION 2

<b>Vulnerable group</b>	Persons aged 60 years or over	<b>Multiple locations</b>	Yes	<b>No</b>
<b>Related hazards</b>	Inadequate lighting	<b>Secondary hazards</b>	Yes	<b>No</b>

A) Stairs from first floor landing



Elevation

A) Stairs from GF passage



A) Plan

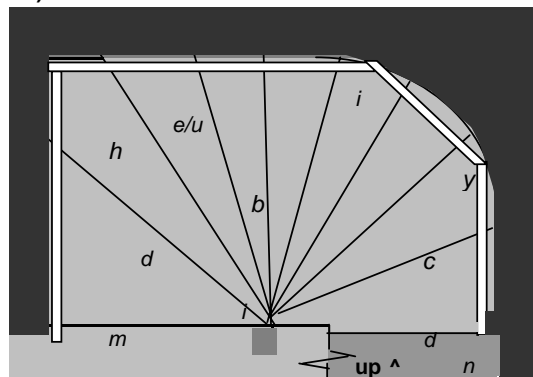

## DESCRIPTION OF HAZARD/S

**Dwelling:** c. 1790 Rural detached cottage

**A) Main stairs:** The stairs comprise extremely steep winders, which have uneven risers and treads. There is a short first floor landing, off which there are two bedrooms; the bathroom and w.c. are on the ground floor. The stairs open into a 1500 mm wide passage on the ground floor. There is no central heating or natural lighting, but artificial lighting is located in the ceiling above the stairs, with a switch on the landing. There is no switch to the landing light at the foot, although the latter is lit by artificial lighting in the passage. The handrail cannot be gripped in the angles where fitted to the surrounding wall.

## LIST OF RELEVANT MATTERS

LIKELIHOOD	A	OUTCOMES	A
a Tread lengths	3	a Length of flight	-
b Riser heights	2	b Pitch of stairs	2
c Variation in T&Rs	3	c Projections etc	1
d Nosing length	-	d Hard surfaces	2
e Poor friction	2	e Construction/repair	1
f Openings - in stairs	-	f Thermal efficiency	2
h-i Lack/height handrails	2		
j-l Lack/height guarding	-	<b># Secondary hazards</b>	<b>A</b>
m Stair width	-	- None	-
n Length of flight	1		
o-q Inadequate lighting etc	3		
r Door/s onto stairs	-	<b>Key</b>	3 Seriously defective
s Inadequate landing	-		2 Defective
t Construction/repair	1		1 Not satisfactory
u Thermal efficiency	2		- Satisfactory/NA

**HEALTH AND SAFETY RATING SYSTEM SCORES**

Pre 1920 House

**LIKELIHOOD** Low → High

**1 in 10**

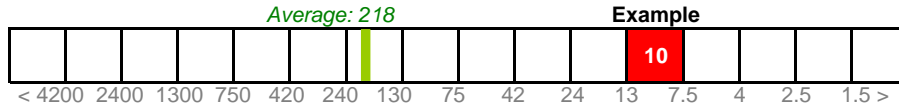

**Justification** The extreme steepness of the stairs, the uneven angles, tread and riser dimensions and poor handrail, particularly the lack of any handrail or grab rail on the inside of the stairs, together with the lack of natural lighting and inconvenient location of the switches to the artificial lighting, all add to the likelihood of a major accident occurring on these stairs.

**OUTCOMES**

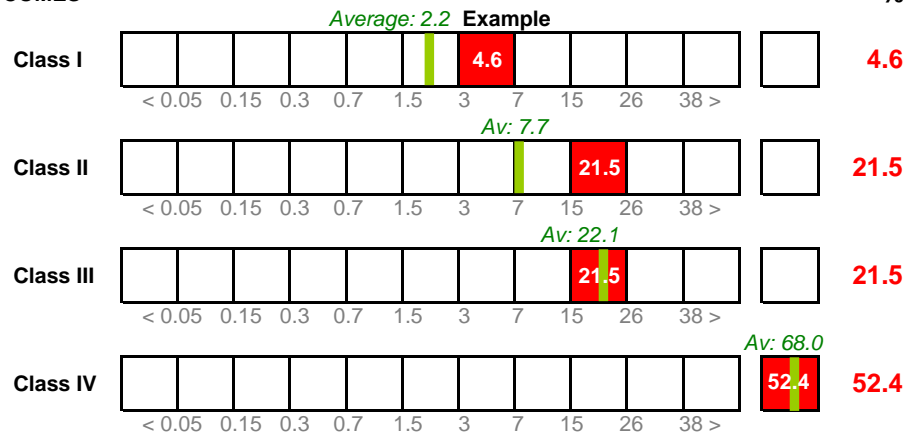

**Justification** Due to the shape of the stairs, a major fall is most likely to involve collision with the curved outer wall and probably the handrail and result in serious or moderate (class III and class IV) outcomes. However, the extreme steepness of the stairs and the possibility of falling vertically between the top and bottom steps significantly increases the risk of a more than serious, fatal or severe accident occurring.

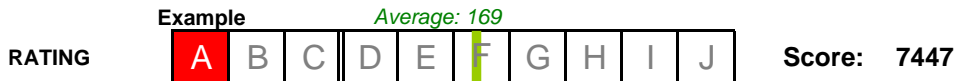

**RATING SCORES AFTER IMPROVEMENT**

**IMPROVE** Likelihood to **1 in 320** Outcomes to **2.2 | 10.0 | 21.5 | 66.3** %

**Justification** The dwelling layout would allow the landing to be widened in places and for the existing stair to be replaced with a true spiral staircase built to conform with modern Building Regulations. This would reduce both the likelihood and spread of harms to average or better than average figures.



*Av: Nos* Average likelihood, outcomes and HHSRS score for falls on stairs and steps by persons aged 60 years or more in and around pre-1920 houses, 1997-99.

# FALLS ON STAIRS ETC

HHSRS VERSION 2

<b>Vulnerable group</b>	Persons aged 60 years or over	<b>Multiple hazards</b>	Yes	<b>No</b>
<b>Related hazards</b>	None	<b>Secondary hazards</b>	Yes	<b>No</b>

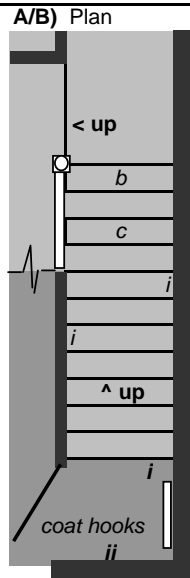
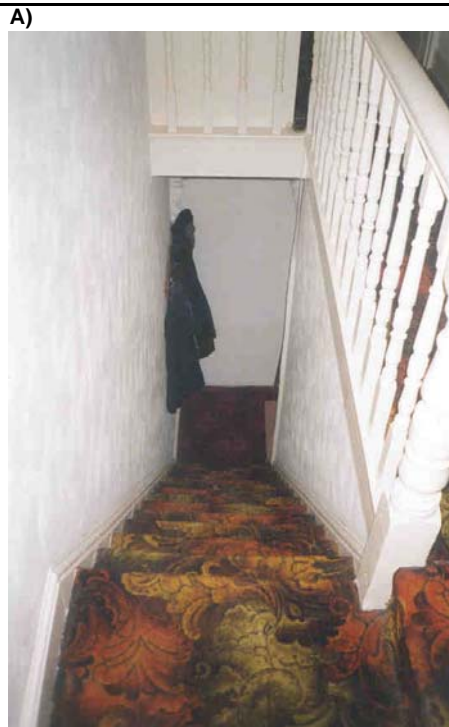

## DESCRIPTION OF HAZARD/S

**Dwelling:** Pre 1920 mid-terraced house

**A) Main stairs:** The straight flight of 13 steps is relatively steep, having risers of over 220 mm and treads of some 220 mm deep. This flight leads from the front room to the first floor corridor serving the bathroom and a third bedroom in the back addition. The top landing serving the two main bedrooms is one further step up from the top of the stairs. There are no handrails on either side of the main flight. Directly opposite the foot of the stairs is a wall on which coat hooks have been fixed. There is no direct natural lighting to the stairs or landing. The stairs also have a loose carpet.

## LIST OF RELEVANT MATTERS

LIKELIHOOD		OUTCOMES	
<i>a</i>	Tread lengths	<i>a</i>	Length of flight
<i>b</i>	Riser heights	<i>b</i>	Pitch of stairs
<i>c</i>	Variation in T&Rs	<i>c</i>	Projections etc
<i>d</i>	Nosing length	<i>d</i>	Hard surfaces
<i>e</i>	Poor friction	<i>e</i>	Construction/repair
<i>f</i>	Openings - in stairs	<i>f</i>	Thermal efficiency
<i>g</i>	Alternating treads		
<i>h-i</i>	Lack/height handrails	<b># Secondary hazards</b>	<b>A</b>
<i>j-l</i>	Lack/height guarding	None	-
<i>m</i>	Stair width		
<i>n</i>	Length of flight		
<i>o-q</i>	Inadequate lighting etc		
<i>r</i>	Door/s onto stairs		
<i>s</i>	Inadequate landing	<b>Key</b>	3 Seriously defective
<i>t</i>	Construction/repair		2 Defective
<i>u</i>	Thermal efficiency		1 Not satisfactory
			- Satisfactory/NA

**HEALTH AND SAFETY RATING SYSTEM SCORES**

Pre 1920 House

LIKELIHOOD Low → High

1 in 100

Average: 218 Example

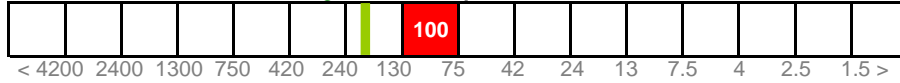

**Justification** Although relatively steep compared to modern stairs, the dimensions of the treads and risers are fairly typical of those found in pre-1919 terraced housing. However, the absence of a handrail on both side of the stairs increases the likelihood of a fall above the average for this type of dwelling. The loosely fitted patterned carpet further increases the actual risk, but this is the owner occupier's responsibility and not a matter for the HHSRS.

**OUTCOMES**

%

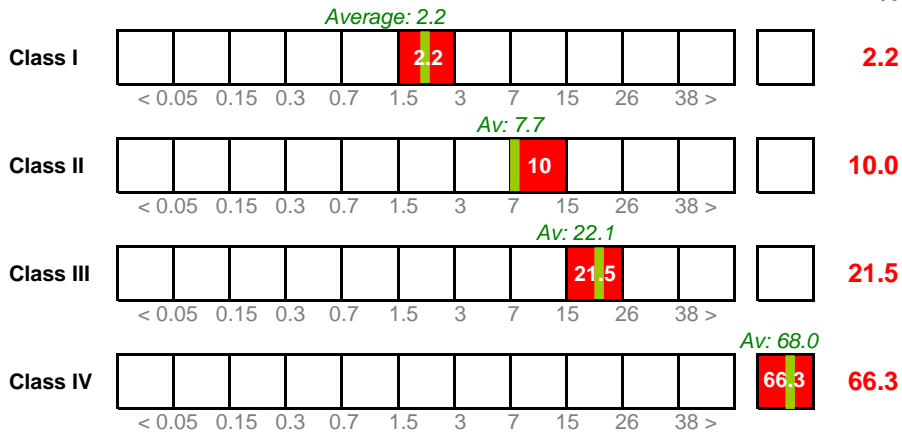

**Justification** The stairs are designed to be carpeted and despite the presence of secondary hazards, in the form of the wall and high level coat hooks directly opposite the foot of the stairs, they are judged not to give significantly higher outcomes than those for the average spread of harms.

Example Average: 169

RATING



Score: 391

**RATING SCORES AFTER IMPROVEMENT**

IMPROVE Likelihood to 1 in 180 Outcomes to 2.2 | 10.0 | 21.5 | 66.3 %

**Justification** Providing handrails to either side of the stairs would reduce the likelihood of a fall and thereby give a rating closer to the average for the age of property. Although not part of the HHSRS, the occupiers should also be informed of the added risk posed by the loosely fitted patterned carpet.

Improved Av: 169

NEW RATING



Score: 217

Av: Nos Average likelihood, outcomes and HHSRS score for falls on stairs and steps by persons aged 60 years or more in and around pre-1920 houses, 1997-99.



# FALLS ON STAIRS ETC

HHSRS VERSION 2

<b>Vulnerable group</b>	Persons aged 60 years or over	<b>Multiple location</b>	Yes	<b>No</b>
<b>Related hazards</b>	None	<b>Secondary hazards</b>	Yes	<b>No</b>

A) Main stairs



A) Plan

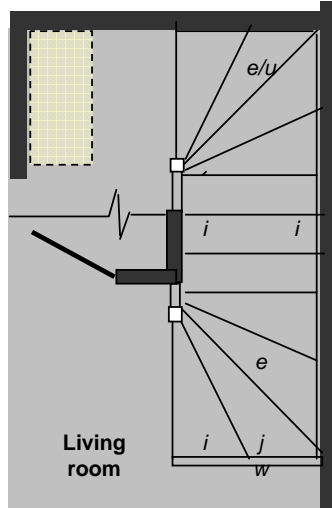

Landing



A) Foot of stairs

Elevation



## DESCRIPTION OF HAZARD/S

**Dwelling:** 1980s, Cluster (starter) house

**A) Main stairs:** The main stairs comprise 3 straight steps in the centre and four winders at the top and four at the bottom, the whole flight turning through 180 degrees. The foot of the stairs is open to the main living room. The top of the stairs ends in a small landing off which are arranged two bedrooms and a bathroom. There is furniture on the landing opposite the top of the stairs. Apart from a short section near the bottom newel post, there is no handrail on the inside of the stair. The rail running on the outside wall is difficult to grasp. There is no rail or guarding at the bottom of the stairs.

## LIST OF RELEVANT MATTERS

LIKELIHOOD	A	OUTCOMES	A
<i>a</i> Tread lengths	-	<i>a</i> Length of flight	-
<i>b</i> Riser heights	-	<i>b</i> Pitch of stairs	-
<i>c</i> Variation in T&Rs	2	<i>c</i> Projections etc	1
<i>d</i> Nosing length	-	<i>d</i> Hard surfaces	1
<i>e</i> Poor friction	-	<i>e</i> Construction/repair	-
<i>f</i> Openings in stairs	-	<i>f</i> Thermal efficiency	-
<i>h-i</i> Lack/height handrails	3		
<i>j-l</i> Lack/height guarding	3	<b># Secondary hazards</b>	
<i>m</i> Stair width	-	- None	-
<i>n</i> Length of flight	-		
<i>o-q</i> Inadequate lighting etc	-		
<i>r</i> Door/s onto stairs	-	<b>Key</b>	3 Seriously defective
<i>s</i> Inadequate landing	-		2 Defective
<i>t</i> Construction/repair	-		1 Not satisfactory
<i>u</i> Thermal efficiency	-		- Satisfactory/NA

**HEALTH AND SAFETY RATING SYSTEM SCORES**

Post 1979 House

LIKELIHOOD Low → High

1 in 180

Average: 256 Example

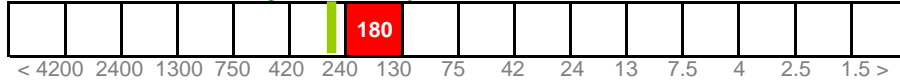

**Justification** Although built to conform to relatively modern standards, the change in the going from winders to a straight flight and back to winders and, particularly, the lack of a good handrail against the centre and top steps and lack of either a handrail or guarding over the lower steps, increases the likelihood of a fall. Due to the increased possibility of distractions, stairs open to living rooms are also known to pose a greater risk of falls.

**OUTCOMES**

%

Average: 1.4 Example

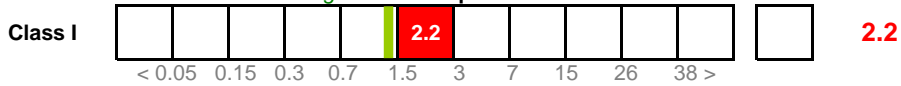

Av: 6.3



Av: 25.2



Av: 67.1

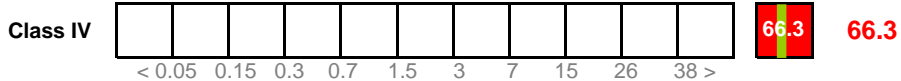

**Justification** The stairs are designed to be carpeted and there are no secondary hazards. However, the lack of guarding near the foot of the stairs and the consequent possibility of a small vertical fall over the end slightly increases the risk of a fatal or severe health outcome from that for the average for the stock.

Example Average: 111

RATING



Score: 217

**RATING SCORES AFTER IMPROVEMENT**

IMPROVE Likelihood to 1 in 180 Outcomes to 1.0 | 4.6 | 21.5 | 72.9 %

**Justification** Providing a handrail and guarding near the foot of the stairs and also providing a better handrail around the outer wall would reduce the outcomes and spread of harms to those average for the stock. The likelihood would remain slightly higher than that for post 1980 dwellings generally due to the remaining alternation of winders and straight steps.

Improved

NEW RATING



Score: 120

Av: Nos Average likelihood, outcomes and HHSRS score for falls on stairs and steps by persons aged 60 years or more in and around post 1979 houses, 1997-99.

# FALLS BETWEEN LEVELS

HHSRS VERSION 2

<b>Vulnerable group</b>	Persons aged under 5 years	<b>Multiple locations</b>	Yes	No
<b>Related hazards</b>	Entrapment and collision	<b>Secondary hazards</b>	Yes	No

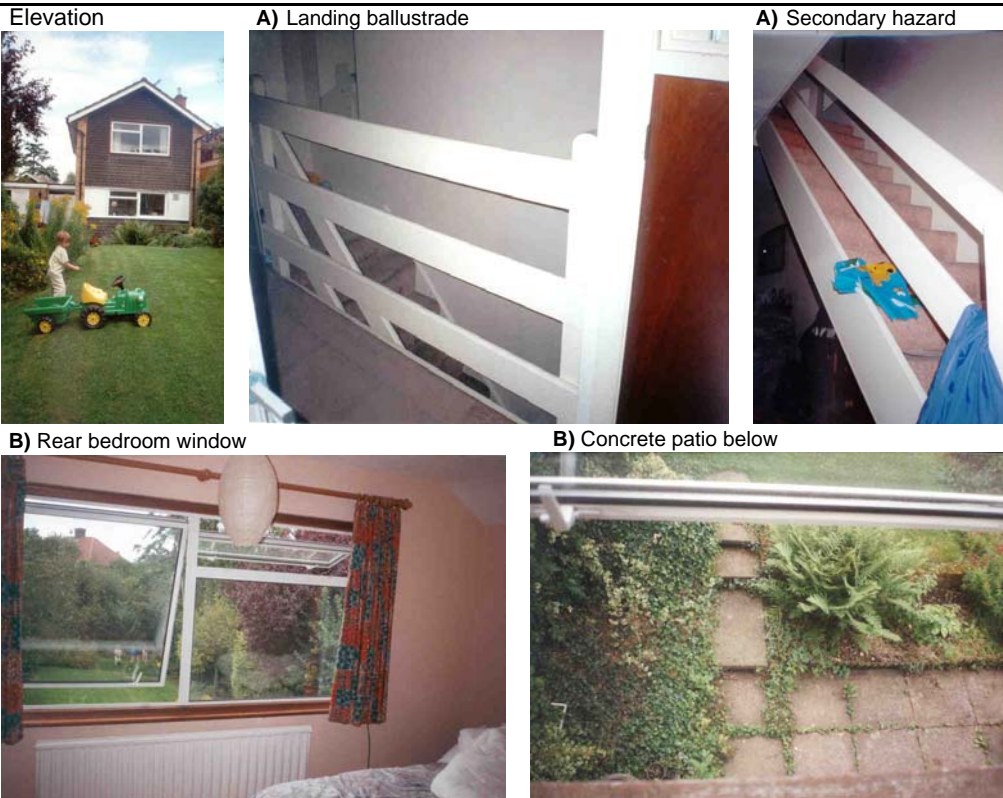

**DESCRIPTION OF HAZARDS** Dwelling: 1970s detached, two bedroomed house

- A) The Landing Balustrade:** This is some 900 mm high and comprises 3 horizontal planks spanning between the top newel post and end post and has continuous horizontal gaps over 200 mm high between. From the landing there is a maximum free fall of some 2 metres to the bottom treads.
- B) Front and rear first floor windows:** Both the front and rear bedrooms windows have a large top-hung opening light, with no safety catch. Both have sills some 850 mm high with radiators below and are some 3.6 m above the ground, which comprises respectively a path and patio of concrete slabs.

## LIST OF RELEVANT MATTERS

LIKELIHOOD	A	B	OUTCOMES	A	B
1 Type of opening light		3	a Height above ground/ level	1	2
a Ease of window operation	-	-	b Nature of ground/ surface #	3	3
b Safety catches	-	3	c Non-safety glass	-	1
c Opening limiters	-	3			
d Sill heights	-	1	<b># Secondary hazards</b>	<b>A</b>	<b>B</b>
e Disrepair of window	-	-	i Stair and balustrade	3	2
f Ease of cleaning	-	3	ii Concrete steps	-	2
g Height of guarding	-	-			
h Easily climbed guarding	3	-			
i Openings in guarding	3	-	<b>Key</b>	3	Seriously defective
j Constrn./repair of guarding	-	-		2	Defective
				-	Satisfactory/NA

**HEALTH AND SAFETY RATING SYSTEM SCORES**

1946-79 House

LIKELIHOOD Low → High

1 in 100

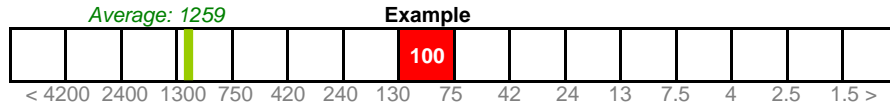

**Justification** The likelihood of a fall from the first floor windows is significantly greater than average due to the position of the catch and manner of opening and presence of this hazard in both bedrooms. There is a greater chance of a small child falling between or over the horizontal balustrates when playing on the landing. The form of the landing balustrate makes it easy and tempting to climb. (Note - the balustrading to stairs is not included under this hazard, but would be taken into account under Falls on Stairs.)

**OUTCOMES**

%

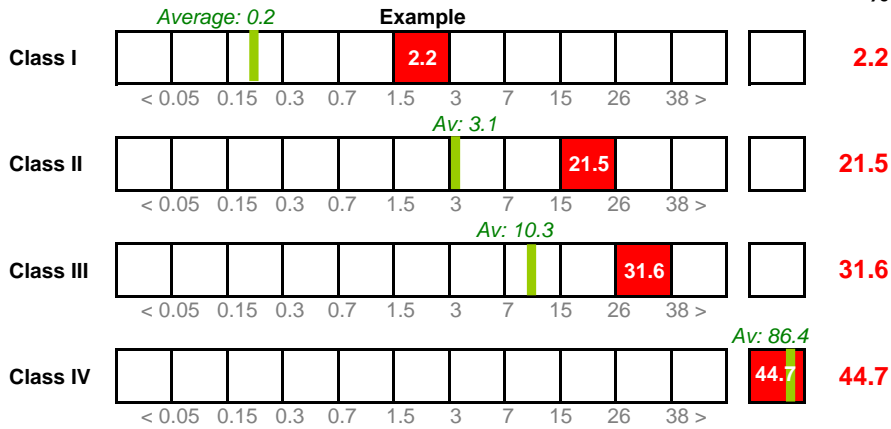

**Justification** The harm outcome of an indoor fall may be reduced by the fact that the stairs and floors are designed to be carpeted, but the stair and balustrade constitutes serious secondary hazards for a fall from the landing. Although much less likely, a fall from the front or rear bedroom window will result in a higher % of fatal and severe outcomes, due to the longer drop and concrete paving below, thereby further worsening the overall spread.



**RATING SCORES AFTER IMPROVEMENT**

IMPROVE Likelihood to 1 in 1,000 Outcomes to 1.0 | 10.0 | 21.5 | 67.5 %

**Justification** Fixing further planks to the landing ballustrade to fill the gaps and make climbing difficult and fitting safety catches on the first floor front and rear windows, would reduce the overall risk of a fall substantially. Removing the concrete slabs immediately below the window and planting bushes would improve the overall spread of harms but less so.



Av: Nos Average likelihood, outcomes and HHSRS score for falls between levels by persons aged under 5 years in and around 1946-79 houses, 1997-99.

# FALLS BETWEEN LEVELS

HHSRS VERSION 2

<b>Vulnerable group</b>	Persons aged under 5 years	<b>Multiple locations</b>	Yes	No
<b>Related hazards</b>	Entrapment & collision	<b>Secondary hazards</b>	Yes	No

A) Front elevation



A) First floor front window



C) Back addition window



B) First floor rear window



## DESCRIPTION OF HAZARD/S

**Dwelling:** Pre 1900 semi-detached

**Background:** All the windows in the dwelling are double hung sashes and made of relatively thin section timber. Most are poorly maintained and, although generally sound, are rotten in places. All have thin single glazing, with some loose putty. None have safety catches.

- A) First floor front window:** The sill to this window is approximately 400 mm above the main front bedroom floor. Some 2.8 metres below the window, the front garden is paved with concrete slabs.
- B/C) First floor rear windows:** The sills to the second and back addition bedrooms are also both under 500 mm above their floors. The rear yard, which is nearly 3 metres below the former, is concreted and bounded by a wooden fence. The back addition window is located above the bathroom roof.

## LIST OF RELEVANT MATTERS

LIKELIHOOD	A	B	OUTCOMES	A	B
1 Type of opening light	3	3	a Height above ground/ level	2	1
a Ease of window operation	2	2	b Nature of ground/ surface	2	2
b Safety catches	2	2	c Non-safety glass #	3	3
c Opening limiters	3	3			
d Sill heights	3	3	# Secondary hazards	A	B
e Disrepair of window	2	2	None		
f Ease of cleaning	2	2			
g Height of guarding	-	-			
h Easily climbed guarding	-	-			
i Openings in guarding	-	-	<b>Key</b> 3 Seriously defective	2	Defective
j Constn./repair of guarding	-	-	1 Not satisfactory	-	Satisfactory/NA

**HEALTH AND SAFETY RATING SYSTEM SCORES**

Pre 1920 House

LIKELIHOOD Low → High

1 in 100

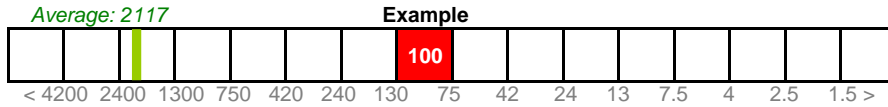

**Justification** The fact that all the first floor windows not only have very low sills but are of somewhat flimsy construction, are in some disrepair and have thin single glazing in relatively large panes, all increases the likelihood of a major accident occurring to well beyond that for the average pre 1920 dwelling.

**OUTCOMES**

%

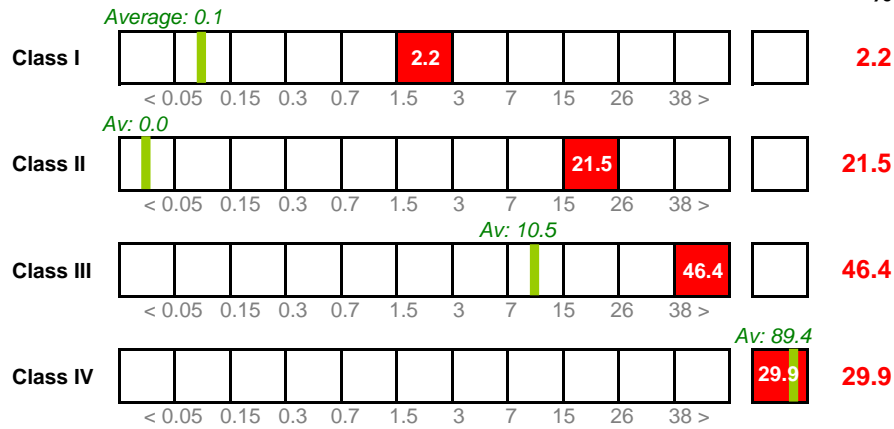

**Justification** Although externally the sills are of only average height from the ground, the increased chance of falling through the glass due to the thin glazing, design and disrepair of the windows and the hard concrete surfaces below the two main bedroom windows, heightens the risk of a fatal, severe or serious outcome occurring as a result of a window accident.



**RATING SCORES AFTER IMPROVEMENT**

IMPROVE Likelihood to 1 in 1,800 Outcomes to 0.1 | 0.0 | 10.0 | 89.9 %

**Justification** Replacing the windows with double glazed units, with safety catches and opening limiters would reduce the likelihood of fall to average and also counter the heightened spread of harms resulting from cuts from the thin single glazing potentially received during the process of falling. The outcomes could be further improved by grassing the front garden.



Av: Nos Average likelihood, outcomes and HHSRS score for falls between levels by persons aged under 5 years in and around pre 1920 houses, 1997-99.



# FALLS BETWEEN LEVELS

HHSRS VERSION 2

<b>Vulnerable group:</b>	Persons aged under 5 years	<b>Multiple locations</b>	Yes	No
<b>Related hazards:</b>	Entrapment & collision	<b>Secondary hazards</b>	Yes	No

A) Front bedroom window



A) Vertical section

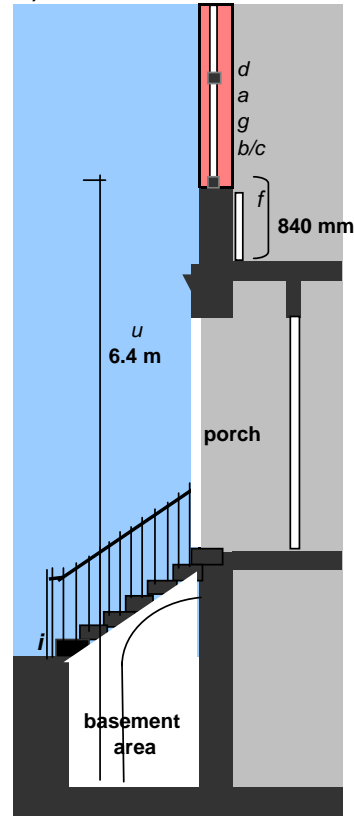

A) Plan

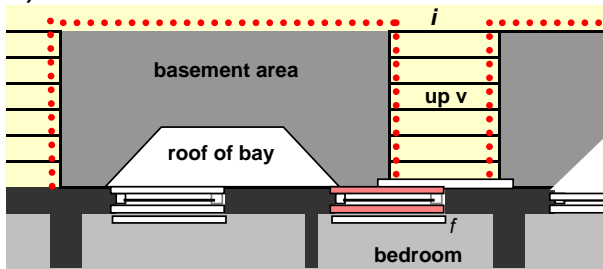

**DESCRIPTION OF HAZARD/S**

**Dwelling:**

First floor flat in c.1890 converted house

**A) First floor front windows** - The window in the smaller front bedroom of the first floor flat comprises a double hung sash. The internal sill is approximately 840 mm above floor level but a wide double radiator runs the full width of the window below the sill. Externally, there is a basement area some 6.4 metres directly below half of the window. About 4.2 metres below the other half of the window are stone entrance steps. Iron railings run either side of these steps and also separate the pavement from the basement area. Other windows in the flat are similar but have fewer secondary hazards.

**LIST OF RELEVANT MATTERS**

**LIKELIHOOD**

<i>1</i> Type of opening light	<b>A</b>	3
<i>a</i> Ease of window operation		2
<i>b</i> Safety catches		2
<i>c</i> Opening limiters		3
<i>d</i> Sill heights		1
<i>e</i> Disrepair of window		-
<i>f</i> Ease of cleaning		2
<i>g</i> Height of guarding		-
<i>h</i> Easily climbed guarding etc		2
<i>i</i> Openings in guarding		-
<i>j</i> Constr./repair of guarding		-

**OUTCOMES**

<i>a</i> Height above ground/ level #	<b>A</b>	2
<i>b</i> Nature of ground/ surface #		3
<i>c</i> Non-safety glass		2
<b># Secondary hazards</b>	<b>A</b>	
<i>1</i> Stone front door steps		2

**Key**

3	Seriously defective	2	Defective
1	Not satisfactory	-	Satisfactory/NA

**HEALTH AND SAFETY RATING SYSTEM SCORES**

Pre 1920 converted s.c. Flat

LIKELIHOOD Low → High

1 in 560

Average: 2742

Example

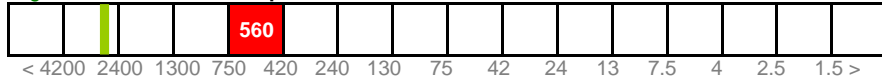

**Justification** The other front window gives access to the unguarded flat roof of the bay. The likelihood of a fall is increased significantly by the relatively low cills, the positioning of the double radiators and the ease with which the lower sashes can be unlatched and lifted.

**OUTCOMES**

%

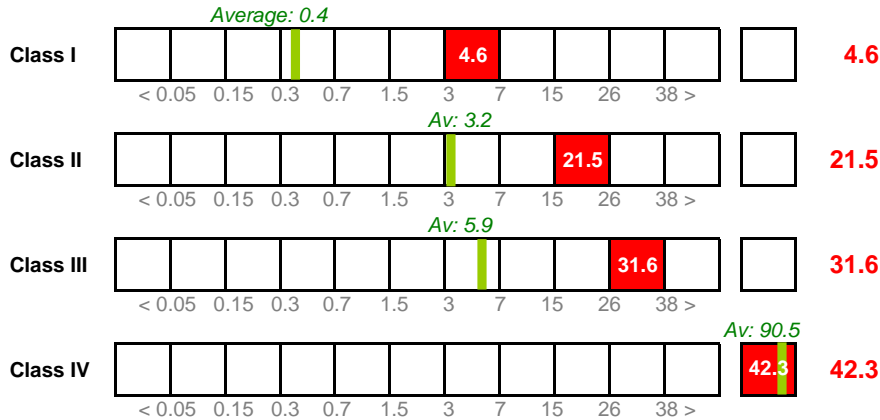

**Justification** A direct fall of over 6 metres is possible from this window and one rear window. The harm outcomes from this particular window are likely to be substantially more severe than from most first floor windows, due to the formidable secondary hazards. These are the concreted basement well, the stone front door steps and, particularly, the iron railings to the stairs and basement which are positioned directly below the centre of the window.

Example

Average: 4

RATING



Score 138

**RATING SCORES AFTER IMPROVEMENT**

IMPROVE Likelihood to 1 in 5,600 Outcomes to 4.6 | 21.5 | 31.6 | 42.3 %

**Justification** There is little that can be done to improve the spread of harms, but providing safety bars and limiters on the windows would substantially reduce the likelihood of a fall, and thereby considerably improve the overall rating.

Improved Av: 3

NEW RATING



Score 13

Av: Nos Average likelihood, outcomes and HHSRS score for falls between levels by persons aged under 5 years in and around pre-1920 flats, 1997-99.

# FALLS BETWEEN LEVELS

HHSRS VERSION 2

<b>Vulnerable group:</b>	Persons aged under 5 years	<b>Multiple locations</b>	Yes	<b>No</b>
<b>Related hazards:</b>	Entrapment & collision	<b>Secondary hazards</b>	Yes	No

A) First floor front bedroom window



A) External view



A) Full opening



A) Plan

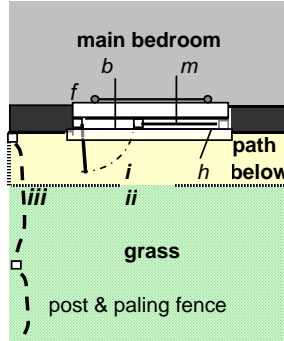

## DESCRIPTION OF HAZARD/S

**Dwelling:** 1930s, Semi detached house, on sloping site

### A)

**First floor front bedroom window:** The house has uPVC double glazed casement windows, which were installed about 5 years ago. The window to the first floor front bedroom comprises a main fixed light below a narrow top hung opening and a side hung opening light. This is fitted with a safety catch, which limits the opening to less than 100 mm. However, the faulty safety catch is easily disengaged allowing the window to be opened to a full 90 degrees. All other windows appear satisfactory.

The sill height is some 900 mm above the bedroom floor, but there is a radiator between. Externally, it is 4.2 metres above a 1 metre wide concrete path. There is a kerb and grassed area in front of this. Below, about one metre to the side of the window, is a sagging wooden post and paling fence.

## LIST OF RELEVANT MATTERS

LIKELIHOOD	A	OUTCOMES	A
1 Type of opening light	1	a Height above window/ level	2
a Ease of window operation	-	b Nature of ground/ surface #	2
b Safety catches	3	c Non-safety glass	-
c Opening limiters	-		
d Sill heights	-	<b># Secondary hazards</b>	<b>A</b>
e Disrepair of window	2	i Concrete kerb	2
f Ease of cleaning	-		
g Height of guarding	-		
h Easily climbed guarding etc	2		
i Openings in guarding	-	<b>Key</b> 3 Seriously defective	2 Defective
j Constn./ repair of guarding	-	1 Not satisfactory	- Satisfactory/NA

**HEALTH AND SAFETY RATING SYSTEM SCORES**

1920-45 House

LIKELIHOOD Low → High

1 in 1800

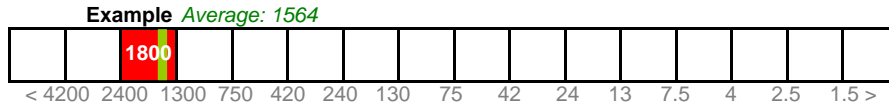

**Justification** Although the sill is at a normal height, it would be possible for a child to use the radiator to climb onto the sill and disengage the safety catch, if the window was left ajar, or for an adult to fall while using the fully open side window to clean the fixed pane. However, with only one such window in the house and this being in the main bedroom, the likelihood of a fall would be no more than average for the stock - that is around 1 in 1,800

**OUTCOMES**

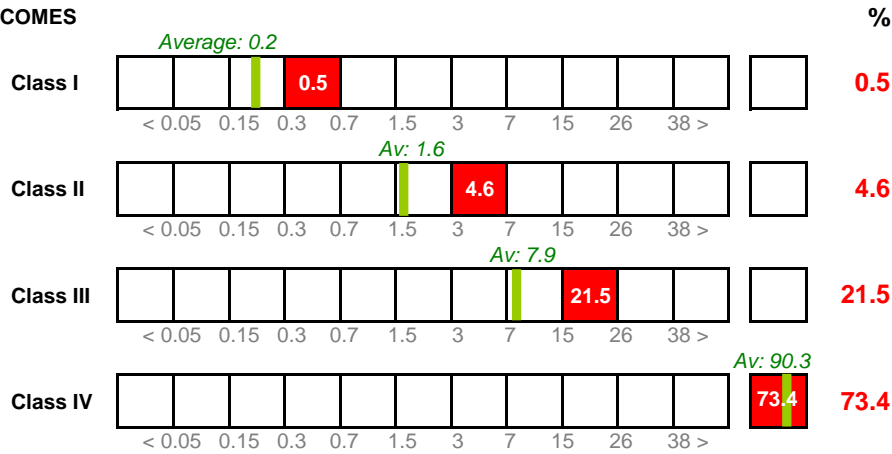

**Justification** Depending on how the person falls, he or she will land wholly on the concrete path or kerb, partly on the path or kerb, wholly on the grass, or on the wooden fence. The latter is unlikely given the way the window opens. The first two possibilities appear the most likely and, with the added height due to the sloping site, the chance of a fatal, severe or serious fall is increased to figures above those for the average spread of harms.



**RATING SCORES AFTER IMPROVEMENT**

**IMPROVE** Likelihood to 1 in 3,200 Outcomes to 0.5 | 4.6 | 21.5 | 73.4 %

**Justification** As the first floor front bedroom window is the only faulty window in the dwelling, fitting a more secure safety catch would reduce the likelihood of a fall to better than average. Given the very small likelihood, removing the concrete path and kerb is not really warranted, so the outcomes remain the same.



Av: Nos Average likelihood, outcomes and HHSRS score for falls between levels by persons aged under 5 years in and around 1920-45 houses, 1997-99.

# ELECTRICAL

HHSRS VERSION 2

<b>Vulnerable group</b>	Persons aged under 5 years	<b>Multiple locations</b>	Yes	No
<b>Related hazards</b>	Fire, Lead	<b>Secondary hazards</b>	Yes	No

**A) Supply, meter and fuses**



Front elevation



**DESCRIPTION OF HAZARDS**

**Dwelling:** 1930's semi-detached house

**Background:** This is a 1930's semi-detached house which has generally undergone very little modernisation since it was built. The electrical system is largely as originally installed.

- A) Supply, meter & fuses:** The main supply, meter and fuses are sited at low level in the ground floor hall. The cover on the fusebox is missing and the wiring above the meter is loose and not fully protected. The wiring is mostly lead covered.
- B) Power circuit:** Many of the power outlets have the original two pin sockets, although one newer circuit with flat three pin sockets has been installed to serve the hall and other ground floor rooms.
- C) Lighting circuit:** The photograph shows the two core, fabric covered wiring to a ceiling light, this being typical of the wiring to lights throughout the house.

**LIST OF RELEVANT MATTERS**

LIKELIHOOD & OUTCOMES	A	B	C	# Secondary hazards	A	B	C
a Electrical installation date	3	3	3	- None	-	-	-
b Number & siting of outlets	-	3	1				
c Fuses and meters	2	-	-				
d Earthing	3	-	-				
e Disrepair of installation	3	3	3	<b>Key</b>	3	2	1
f Presence of water	-	-	-				
g Lightning protection system	-	-	-				
					-		

3 Seriously defective  
 2 Defective  
 1 Not satisfactory  
 - Satisfactory/NA

**HEALTH AND SAFETY RATING SYSTEM SCORES**

1920-45 House

LIKELIHOOD Low → High

1 in 10

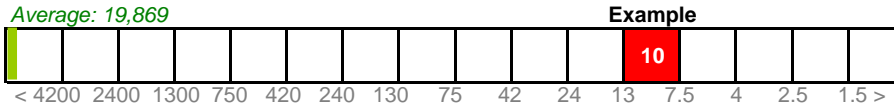

**Justification** The open fusebox and exposed wiring above the meter in the hall is particularly dangerous and tempting to young children. The limited number of 3 pin socket outlets is also likely to encourage both the use of extension leads and two pin plugs throughout the house. As well as the increased risk of electrocution, there is also an increased risk of fire, due to the old wiring and overloading of circuits.

**OUTCOMES**

%

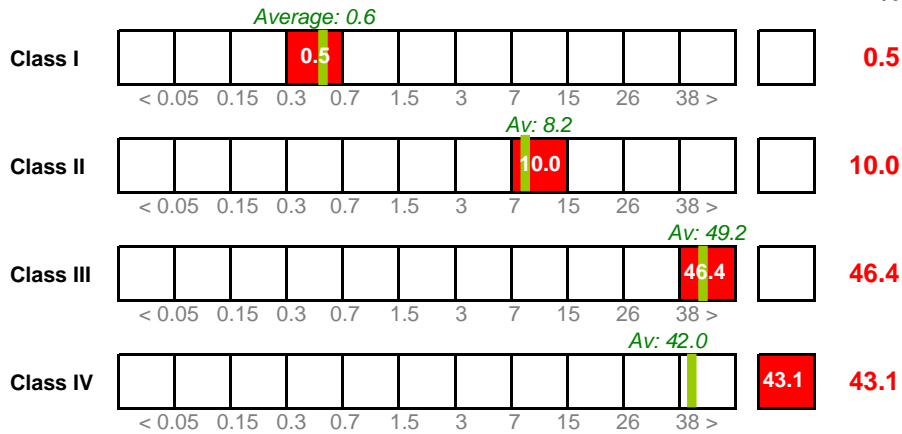

**Justification** Although the risk of serious electrocution is much higher than average, the spread of harms resulting from this does not change. However, with the very high likelihood of a serious occurrence this would give a high score of 2,935 and a hazard rating of B.



**RATING SCORES AFTER IMPROVEMENT**

IMPROVE Likelihood to 1 in 5,600 Outcomes to 0.5 | 10.0 | 46.4 | 43.1 %

**Justification** The house needs to be totally rewired and a new meter, fusebox and new and increased socket outlets installed, all to meet the 16th edition of the IEE Regulations. This should reduce the likelihood of serious harm to better than average, but the standard average spread of outcomes. Using the lowest standard likelihood, this would give a score of 5 and Band J.



Av: Nos Average likelihood, outcomes and HHSRS score for electrical hazards for persons aged under 5 years in all dwellings, 1997-99.



# ELECTRICAL

HHSRS VERSION 2

**Vulnerable group** Persons aged under 5 years  
**Related hazards** Damp and mould growth

**Multiple locations** Yes **No**  
**Secondary hazards** Yes **No**

**A) Supply, meter and fuses**

Front elevation



**DESCRIPTION OF HAZARDS**

**Dwelling:** 1950s 3 bedroomed terraced house

**Background:** This is a end-terraced house built in the 1950s. Hot water is normally supplied by a gas-fired central heating boiler, but the early, foam insulated, hot water cylinder also has an electric immersion heater.

**A) Immersion Heater:-** The gasket around the hole where the immersion heater enters the cylinder has perished resulting in a small but continuous leak. Water is not only running down the loose electric lead to the heater, but also onto the timber shelf holding the cylinder and down the side wall of the airing cupboard on which the switch to the immersion heater is located. The plaster skim and plasterboard above and behind the switch box is now thoroughly soaked. The householder has placed a bowl to catch any directly dripping water.

**LIST OF RELEVANT MATTERS**

LIKELIHOOD & OUTCOMES	A	# Secondary hazards	A
a Electrical installation out of date	2	- None	-
b Number and siting of outlets	-		
c Fuses and meters	-		
d Earthing	-	<b>Key</b>	3 Seriously defective
e Disrepair of installation	3		2 Defective
f Presence of water	3		1 Not satisfactory
g Lightning protection system	-		- Satisfactory/NA

**HEALTH AND SAFETY RATING SYSTEM SCORES**

1946-79 House

**LIKELIHOOD** Low → High

**1 in 180**

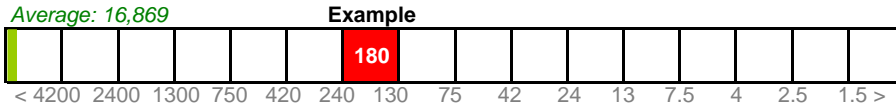

**Justification** The water seeping into the switch box could give rise to an electrical accident, particularly for adults. However, the greatest risk is to children. To reach the affected area, young children would need to find the cupboard door open and climb the shelving, although the presence of bathroom toys in the cupboard might encourage this. There is a further danger that the loose lead could be used to assist such a climb and pulled away from the heater while switched on.

**OUTCOMES**

%

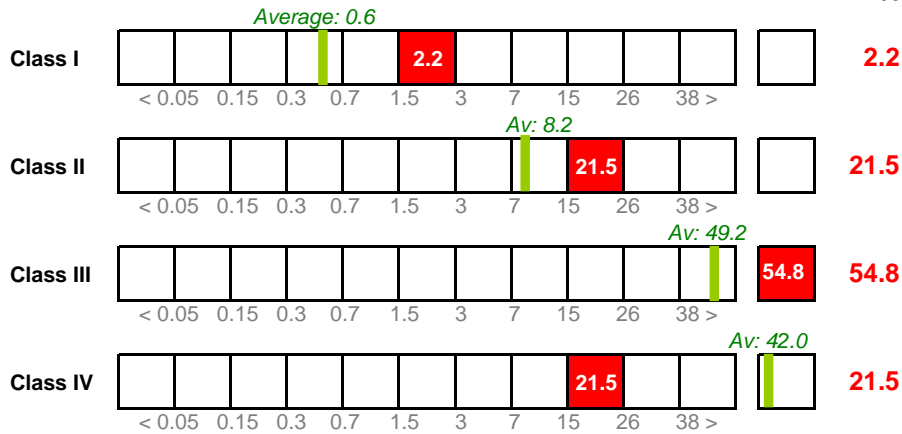

**Justification** There is a possibility that the water collected in the bowl could be spilt over the child during the climb. This could increase the harm outcomes by, for example, conducting the electricity through the child's clothing. This increased spread of health outcomes on top of the above average likelihood would give a hazard score of 334 and a band E rating.

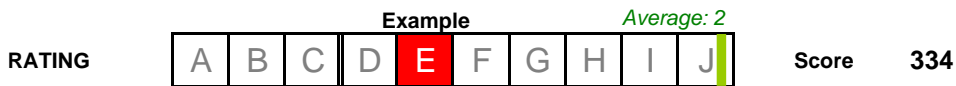

**RATING SCORES AFTER IMPROVEMENT**

**IMPROVE** Likelihood to **1 in 5,600** Outcomes to **0.5 | 10.0 | 46.4 | 43.1 %**

**Justification** Although the main hazard comes from the switch, this does not appear defective. The immersion heater needs replacing and rewiring to current standards, ensuring that the cable is securely fixed. With no other major electrical installation faults in the house, this would reduce the hazard score to the average for the stock.



*Av: Nos* Average likelihood, outcomes and HHSRS score for electrical hazards for persons aged under 5 years in all dwellings, 1997-99.

# FIRE

HHSRS VERSION 2

**Vulnerable group:** Persons aged 60 years or over  
**Related hazards:** None

**Multiple locations** Yes No  
**Secondary hazards** Yes No

Front elevation



Rear elevation



**Dwelling:** First floor front left bedsit, in a 1900, three storey, terraced HMO.

## DESCRIPTION OF HAZARDS

**Background:** There are six bedsits in the house; 2 to each floor. There is a common combined bathroom/wc to the first floor and a common kitchen to the ground floor. There is a whb (with h&c) and a micro-wave cooker to each bedsit. Space heating is by fitted gas fires to each bedsit.

**A) Fire Precautions and Means of Escape:** All internal doors are standard panel doors. The staircase is not enclosed. There are no smoke or heat detectors and no fire alarms. Three fire extinguishers (water) are provided, one to each floor. The electric wiring appears to have been adapted, but not to current standards.

## LIST OF RELEVANT MATTERS

### LIKELIHOOD

<i>a</i> Heater/cooker position	-
<i>b</i> Space heating	1
<i>c</i> Defects to heating	-
<i>d</i> Clothes drying facilities	-
<i>e</i> Number/siting of sockets	3
<i>f</i> Electrical installation	3
<i>g</i> Non-fire resistant fabric	3
<i>h</i> Smoke permeable fabric	3
<i>l</i> Fire stops to cavities	-
<i>J</i> Disrepair to fabric	-
<i>k</i> Internal doors	3
<i>l</i> Self-closers	3
<i>m</i> Smoke/heat detectors	3
<i>n</i> Fire fighting equipment	2
<i>o</i> Lightning protection system	-

### OUTCOMES

<i>a</i> Smoke/heat detectors	3
<i>b</i> Means of escape	3
<i>c</i> Combustible furnishings	-
<i>d</i> Fire fighting equipment	2
<i>e</i> Lighting protection system	-

### # Secondary hazards

- None	-
--------	---

<b>Key</b>	3	Seriously defective
	2	Defective
	1	Not satisfactory
	-	Satisfactory/NA

**HEALTH AND SAFETY RATING SYSTEM SCORES**

Pre 1920 non s.c. Flat

LIKELIHOOD Low → High

1 in 56

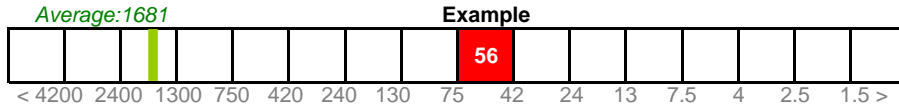

**Justification** **First floor front dwelling:** The condition of the dwelling, the common parts and house as a whole indicate a significant increase in the likelihood of fire starting either within this dwelling or in other parts of the house. The lack of precautions and adaptations mean a fire can spread easily throughout the house wherever it started. Inadequate fire fighting equipment means there is little chance of limiting a fire.

**OUTCOMES**

%

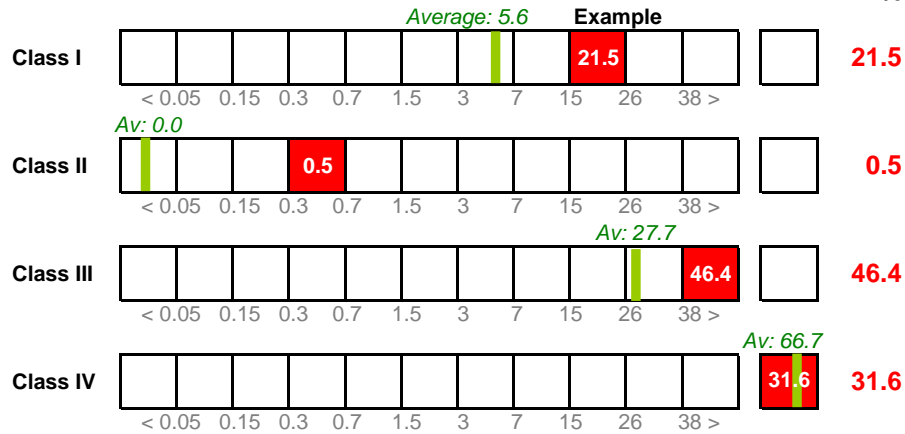

**Justification** The lack of detectors and alarms, and the lack of safe means of escape, substantially increases the risk of fatal, severe and serious outcomes occurring as a result of a fire.

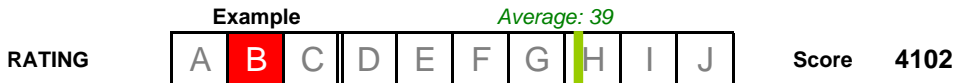

**RATING SCORES AFTER IMPROVEMENT**

IMPROVE Likelihood to 1 in 560 Outcomes to 10.0 | 0.0 | 46.4 | 43.6 %

**Justification** Major works are necessary to reduce both the likelihood and the seriousness of the outcomes. These would include electrical rewiring, installation of fire doors and a protected means of escape, a fire detector and alarm system and fire fighting equipment. Even so, as a house in multiple occupation, the fire risk will be higher than for a single household occupied house.

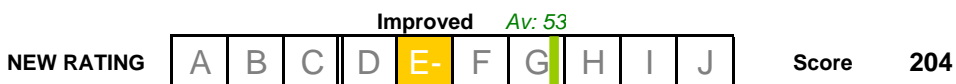

Av: Nos Average likelihood, outcomes and HHSRS score for risk of fire for persons aged 60 years or more in pre-1920 or all flats, 1997-99.

# FIRE

HHSRS VERSION 2

<b>Vulnerable group</b>	Persons aged 60 years or over	<b>Multiple locations</b>	Yes	No
<b>Related hazards</b>	Hot surfaces etc	<b>Secondary hazards</b>	Yes	No

A) Kitchen area of main room



Front elevation



A) Detail of hob



A) Plan

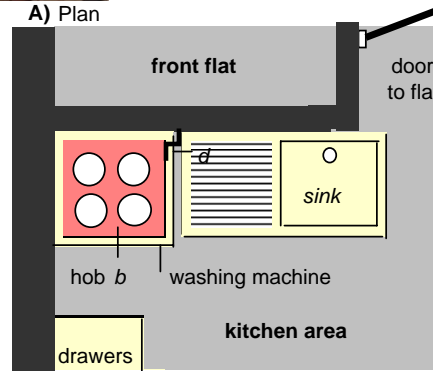

## DESCRIPTION OF HAZARD/S

**Dwelling:** Ground floor rear bedsit in 1900s end-terraced house (HMO)

**Background :** The house was poorly converted to flats and bedsits around 15 years ago. This flat comprises a bedroom and a kitchen/diner. Personal washing and sanitary accommodation are shared with three other lettings. The main photograph shows the kitchen area to the flat.

- A) Gas hob:** The only means of cooking is a gas hob resting on top of the washing machine placed in the corner of the room. There is no smoke/heat detector in the flat but one in the common hall from which the flat is entered. The flat also has direct access to the rear garden through a door in the bedroom.

## LIST OF RELEVANT MATTERS

LIKELIHOOD	A	OUTCOMES	A
a Heater/cooker position	3	a Smoke/heat detectors	2
b Space heating	-	b Combustible furnishings	-
c Defects to heating	3	c Means of escape	-
d Clothes drying facilities	-	d Fire fighting equipment	3
e Number/siting of sockets	-	e Lighting protection system	-
f Electrical installation	-		
g Non-fire resistant fabric	-	<b># Secondary hazards</b>	<b>A</b>
h Smoke permeable fabric	-	- None	-
i Fire stops to cavities	-		
j Disrepair to fabric	-		
k Internal doors	-		
l Self-closers	-		
m Smoke/heat detectors	2	<b>Key</b>	3 Seriously defective
n Fire fighting equipment	1		2 Defective
o Lightning protection system	-		1 Not satisfactory
			- Satisfactory/NA

**HEALTH AND SAFETY RATING SYSTEM SCORES**

Pre 1920 non s.c. Flat

LIKELIHOOD Low → High

1 in 100

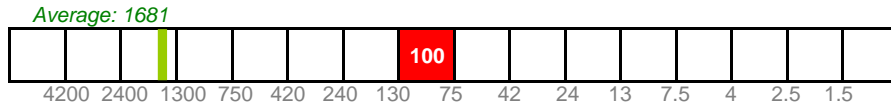

**Justification** **Ground floor rear dwelling:** The siting of the gas hob directly on the washing machine, without any fixing or intervening heat insulation, the loose gas pipe and its position in the extreme corner of the room, close to wooden kitchen fittings, presents a fire risk substantially above the average for pre 1920 flats .

**OUTCOMES**

%

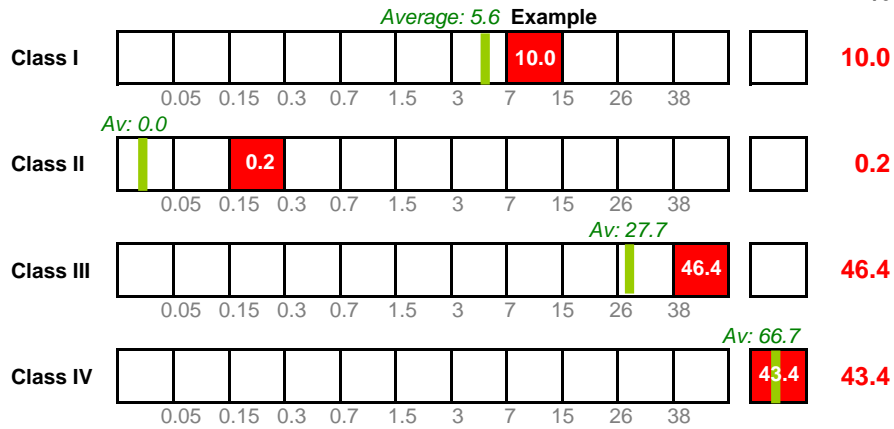

**Justification** The flat has good means of escape; the kitchen/diner has direct access to the front door via the hall, while the bedroom contains a door to the garden. Consequently, notwithstanding the lack of a smoke/heat detector in the flat (there is a battery operated one in the hall), the spread of harms is judged to be very only a little greater than average.

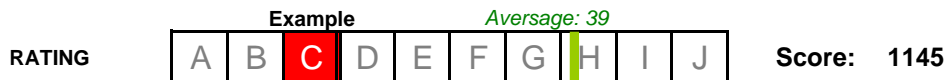

**RATING SCORES AFTER IMPROVEMENT**

**IMPROVE** Likelihood to 1 in 1,800 Outcomes to 10.0 | 0.0 | 46.4 | 43.6 %

**Justification** Despite the flat being in a multi-occupied building, the provision of a proper cooker unit located in a safe position in the room would reduce the risk of fire to near average for this age of dwelling (1 in 1,800) and thereby reduce the rating to band G.

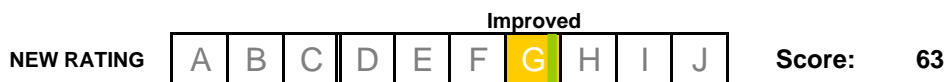

Av: Nos Average likelihood, outcomes and HHSRS score for risk of fire for persons aged 60 years or more in pre-1920 or all flats, 1997-99.



# FIRE

## HHSRS VERSION 2

**Vulnerable group:** Persons aged 60 years or over  
**Related hazards:**

**Multiple locations** Yes No  
**Secondary hazards** Yes No

Front elevation



Closer view of main windows



**Dwelling:** 1938, two storey detached house

**A) Means of escape:** During the 1950's, the timber framed casement windows to all elevations were replaced with aluminum framed, double glazed units with fixed lights and small top hung opening casements. The main form of heating is open coal fire with back boiler serving radiators to the ground floor only, but this is supplemented by portable electric radiant fires and a paraffin heater. There is an electric cooker. There are no smoke/heat detectors or alarms.

### LIST OF RELEVANT MATTERS

**LIKELIHOOD**

	<b>A</b>
<i>a</i> Heater/cooker position	2
<i>b</i> Space heating	2
<i>c</i> Defects to heating	-
<i>d</i> Clothes drying facilities	-
<i>e</i> Number/siting of sockets	-
<i>f</i> Electrical installation	-
<i>g</i> Non-fire resistant fabric	-
<i>h</i> Smoke permeable fabric	-
<i>i</i> Fire stops to cavities	-
<i>j</i> Disrepair to fabric	-
<i>k</i> Internal doors	-
<i>l</i> Self-closers	-
<i>m</i> Smoke/heat detectors	3
<i>n</i> Fire fighting equipment	2
<i>o</i> Lightning protection system	-

**OUTCOMES**

	<b>A</b>
<i>a</i> Smoke/heat detectors	3
<i>b</i> Means of escape	3
<i>c</i> Combustible furnishings	-
<i>d</i> Fire fighting equipment	1
<i>e</i> Lighting protection system	-

**# Secondary hazards**  
 None

<b>Key</b>	
3	Seriously defective
2	Defective
1	Not satisfactory
-	Satisfactory/NA

**HEALTH AND SAFETY RATING SYSTEM SCORES**

1920-45 House

**LIKELIHOOD**

1 in 320

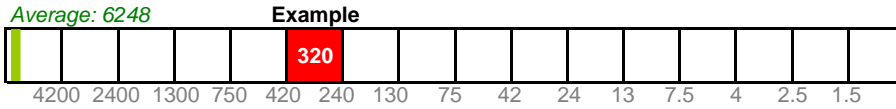

**Justification** The use of open coal fires and, particularly, the supplementary use of portable electric radiant and paraffin heaters which is a direct consequence of the inadequate fixed heating, significantly increases the risk of fire over and above that average for this age of dwelling.

**OUTCOMES**

%

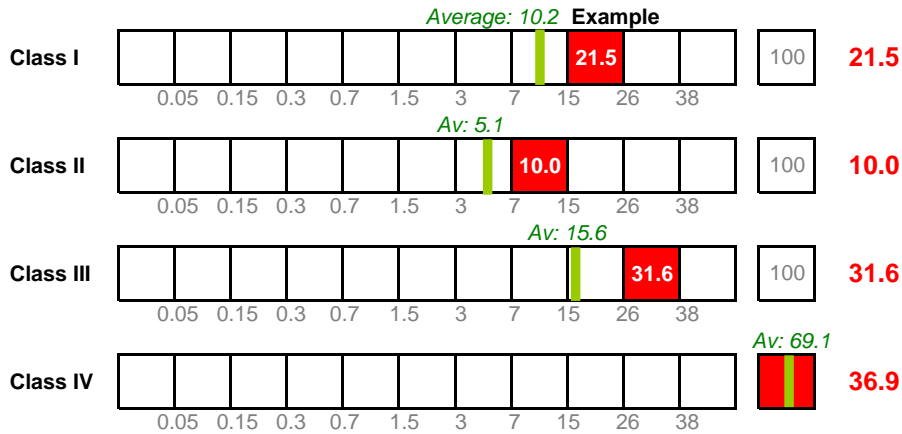

**Justification** The lack of fire detectors and the limited means of escape resulting from the use of fixed glazing in all windows, substantially increases the risk of fatal, severe and serious outcomes occurring as a result of a fire.



**RATING SCORES AFTER IMPROVEMENT**

**IMPROVE** Likelihood to 1 in 3,200 Outcomes to 10.0 | 4.6 | 21.5 | 63.9 %

**Justification** The installation of central heating and the provision of smoke detectors/alarms and openable casements to the windows, particularly those on the first floor, would reduce both the likelihood of a fire, and the spread of outcomes to closer to the average for this age of dwelling.



Av: Nos Average likelihood, outcomes and HHSRS score for risk of fire for persons aged 60 years or more in 1920-45 houses, 1997-99.

# FIRE

HHSRS VERSION 2

<b>Vulnerable group</b>	Persons aged 60 years or over	<b>Multiple locations</b>	Yes	<b>No</b>
<b>Related hazards</b>	Hot surfaces	<b>Secondary hazards</b>	Yes	<b>No</b>

A) Gas heater in bedroom



Elevation



A) Close up of heater



A) Room plan

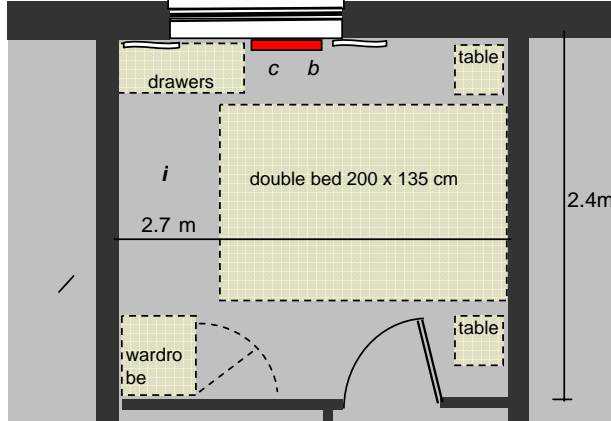

**DESCRIPTION OF HAZARDS**

**Dwelling:** 1980's 'Cluster', 1 bedroomed, starter house

A) A gas convector fire is situated directly under the bedroom window, such that the curtains drape over the fire. The small size and shape of the room and door position make it difficult to position the furniture - a double bed, a small wardrobe, chest of drawers and bedside tables - without the bedding also being in close proximity to the fire. The dwelling has one smoke detector.

**LIST OF RELEVANT MATTERS**

LIKELIHOOD	A	OUTCOMES	A
a Heater/cooker position	3	a Smoke/heat detectors	1
b Space heating	2	b Means of escape	-
c Defects to heating	-	c Combustible furnishings	-
d Clothes drying facilities	-	d Fire fighting equipment	1
e Number/siting of sockets	-	e Lighting protection system	-
f Electrical installation	-		
g Non-fire resistant fabric	-	<b># Secondary hazards</b>	<b>A</b>
h Smoke permeable fabric	-	- None	
i Fire stops to cavities	-		
j Defects to fabric	-	<b>Key</b>	
k-l Internal doors/self-closers	-	3 Seriously defective	
m Smoke/heat detectors	-	2 Defective	
n Fire fighting equipment	-	1 Not satisfactory	
		- Satisfactory/NA	

**HEALTH AND SAFETY RATING SYSTEM SCORES**

Post 1979 House

**LIKELIHOOD**

1 in 320

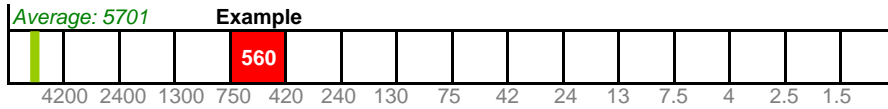

**Justification** Shortening the curtains to lessen the fire risk is the responsibility of the owner-occupier or tenant. However, the fixed position of the gas convector heater means that, even if this were done, there would remain an increased risk of the curtains catching fire. Similarly, the small size and shape of the room and door position make it difficult, if not impossible, to position the bed away from the fire, thereby also increasing the risk of fire.

**OUTCOMES**

%

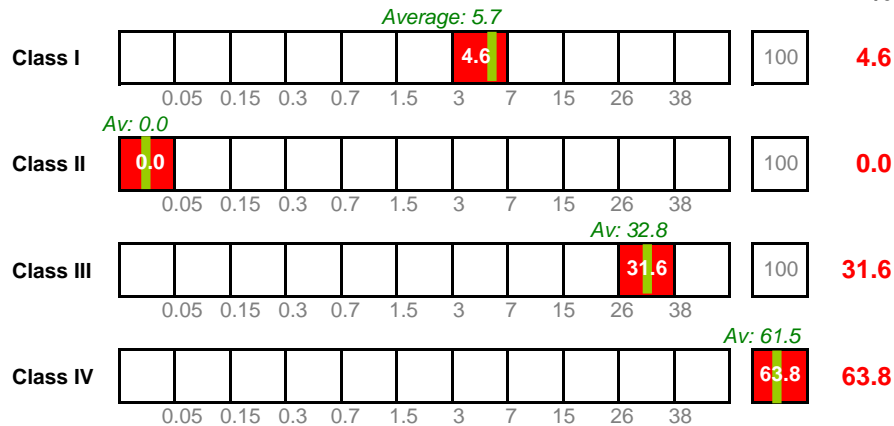

**Justification** The dwelling has one smoke alarm (albeit battery operated) and generally provides a relatively straightforward and easy means of escape, both through the doors and via the windows. Consequently, in the event of a fire in the bedroom, there is nothing to indicate that the likely spread of harms would be either significantly more or less than average (67% of all occupied dwellings now have smoke alarms).



**RATING SCORES AFTER IMPROVEMENT**

**IMPROVE** Likelihood to 1 in 3,200 Outcomes to 4.6 | 0.0 | 31.6 | 63.8 %

**Justification** Replacing the gas convector heater, ideally with a radiator served by a water-borne central heating system would reduce the likelihood of a fire to that average for the post 1980 stock. With no change in the spread of harms, this would give a new score of under 20 and reduce the rating band from F to I.



Av: Nos Average likelihood, outcomes and HHSRS score for risk of fire for persons aged 60 years or more in post 1979 houses, 1997-99.

# HOT SURFACES ETC

HHSRS VERSION 2

<b>Vulnerable age</b>	Persons aged under 5 years	<b>Multiple locations</b>	Yes	<b>No</b>
<b>Related hazards</b>	Food safety, Falls on level	<b>Secondary hazards</b>	Yes	No

A) Cooker behind door



A) Floor plan

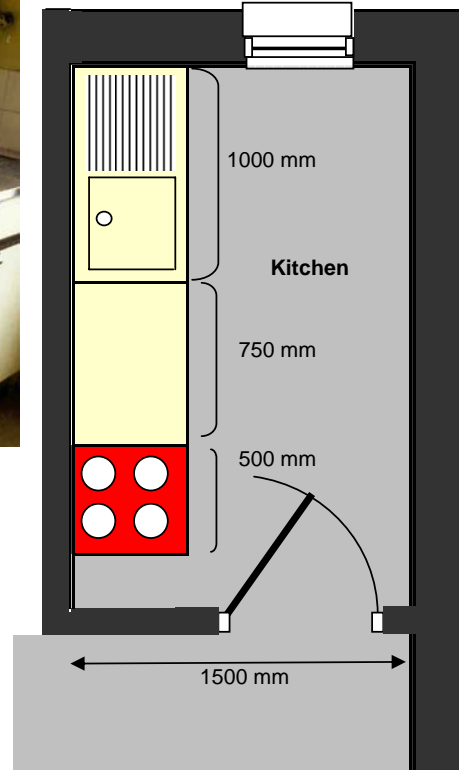

**DESCRIPTION OF HAZARD/S**

**Dwelling:** Pre-1920, 3 bedroom, semi-detached house

**A) Narrow kitchen:** The small kitchen is 2.5 m long by 1.5 m wide. Arranged at one end of one of the longer walls is a 1000 x 500 mm, single drainer sink above a sink unit, with a drawer and cupboards below, and a 500 x 500 mm freestanding gas cooker at the other end. A worktop, which is inadequate in terms of its area, construction and cleanability, is provided by a crude 750 x 500 mm sheet of chipboard spanning between the sink and cooker. The kitchen door opens directly in front of the cooker. The kitchen has a vinyl tiled floor which is worn and lifting in places.

**LIST OF RELEVANT MATTERS**

LIKELIHOOD	A	OUTCOMES	A
<i>a</i> Unprotected hot surfaces	-	<i>a</i> Surface/liquid temperature	-
<i>b</i> Unguarded open flames	2	<i>b</i> Exposure	-
<i>c</i> Hot water to bath	-		
<i>d</i> Hot water to sink	-	<b># Secondary hazards</b>	<b>A</b>
<i>e</i> Thermostatic taps	-	Disrepair of floor	2
<i>f</i> Kitchen layout	3		
<i>g</i> Inadequate separation	-		
<i>h</i> Disrepair	3	<b>Key</b>	<b>3</b> Seriously defective
<i>i</i> Inadequate space	3		<b>2</b> Defective
			<b>1</b> Not satisfactory
			- Satisfactory

**HEALTH AND SAFETY RATING SYSTEM SCORES**

Pre 1920 House

LIKELIHOOD Low → High

1 in 6

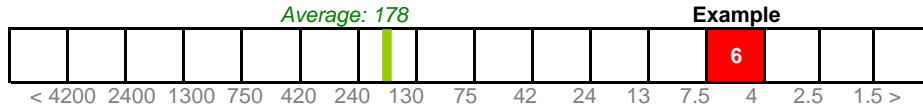

**Justification** With the door shut, ajar or even half open as shown, anyone standing at the cooker handling hot chip or saucepans or retrieving hot items from the oven is likely to be fully hidden from anyone entering the kitchen. Because the consequent danger will often not be apparent to those entering the kitchen, the likelihood of an accident occurring is increased very considerably. In addition, the state of the floor could mean a mis-step and accident.

**OUTCOMES**

%

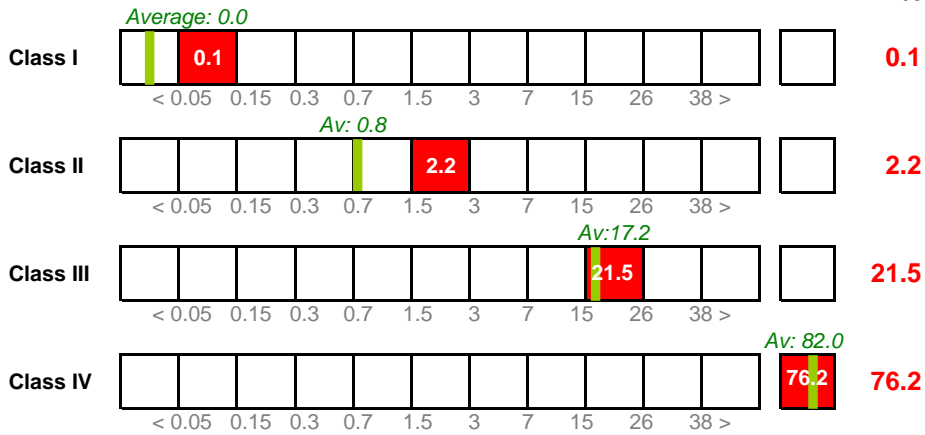

**Justification** If opened quickly, the door is liable to crash into the 'cook' and depending on what is being handled at the time, he or she, or a small child at their side, could receive severe burns or scalds as a result. This is liable to increase the risk of a fatal or severe accident occurring.



**RATING SCORES AFTER IMPROVEMENT**

IMPROVE Likelihood to 1 in 56 Outcomes to 0.0 | 1.0 | 21.5 | 77.5 %

**Justification** Improving the facilities for the preparation and cooking of food - by resiting the sink under the window and the cooker half way along the side wall and providing proper units with worktops either side of the cooker - would reduce both the likelihood and spread of harms. However, due to the narrowness of the kitchen, particularly in front of the cooker, the likelihood and resulting rating would remain higher than average.



Av: Nos Average likelihood, outcomes and HHSRS score for hazards from hot surfaces and materials by persons aged under 5 years in pre-1920 houses, 1997-99.





# HOT SURFACES ETC

HHSRS VERSION 2

<b>Vulnerable age</b>	Persons aged under 5 years	<b>Multiple locations</b>	<b>Yes</b>	<b>No</b>
<b>Related hazards</b>	Fire risk, Excessive heat	<b>Secondary hazards</b>	Yes	No

A) Uninsulated central heating pipes



A) Gap at foot of bed



Maisonette



Block elevation



A) Plan of maisonette

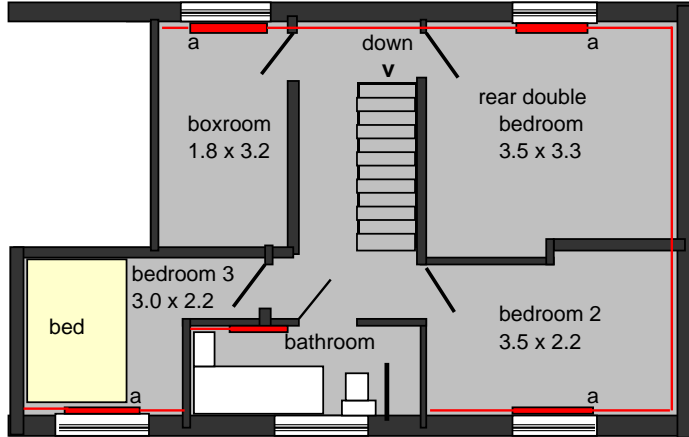

## DESCRIPTION OF HAZARD/S

Dwelling: 1930's 3 bedroomed maisonette

**A) Heating pipes:** The photographs show the uninsulated central heating pipes in the third bedroom of a 3 bedroomed maisonette on the top two floors of a six storey gallery access, walk-up block. The uninsulated pipes from the district heating system are exposed adjacent to the radiators in most of the rooms in the flat, despite the temperature of the pipes being in excess of 80 degrees C. High temperatures are required by the long distribution runs from the estate's boiler house and the tenants have no control on the output of the system, other than the manual valves on each individual radiator. In the third bedroom, the only position for the bed means that there is a gap between the foot of the bed and the exposed pipes.

## LIST OF RELEVANT MATTERS

<b>LIKELIHOOD</b>	<b>A</b>	<b>OUTCOMES</b>	<b>A</b>
a Unprotected hot surfaces	3	a Surface/liquid temperature	3
b Unguarded open flames	-	b Exposure	3
c Hot water to bath	-		
d Hot water to sink	-	<b># Secondary hazards</b>	<b>A</b>
e Thermostatic taps	-	None	-
f Kitchen layout	-		
g Inadequate separation	-		
h Disrepair	-	<b>Key</b>	<b>3</b> Seriously defective
i Inadequate space	3		<b>2</b> Defective
			<b>1</b> Not satisfactory
			- Satisfactory

**HEALTH AND SAFETY RATING SYSTEM SCORES**

1920-45 s/c Flats

LIKELIHOOD Low → High

1 in 18

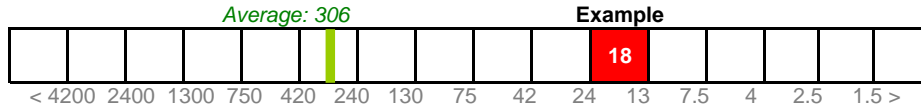

**Justification** The central heating pipes are both exposed and at a readily accessible height in most of the rooms in the maisonette and particularly in the smaller bedrooms, most likely to be occupied by small children. This and the high temperature at which this district heating system is run and lack of individual control, means that the risk of an accident is substantially higher than in an average dwelling with its own water-borne central heating system.

**OUTCOMES**

%

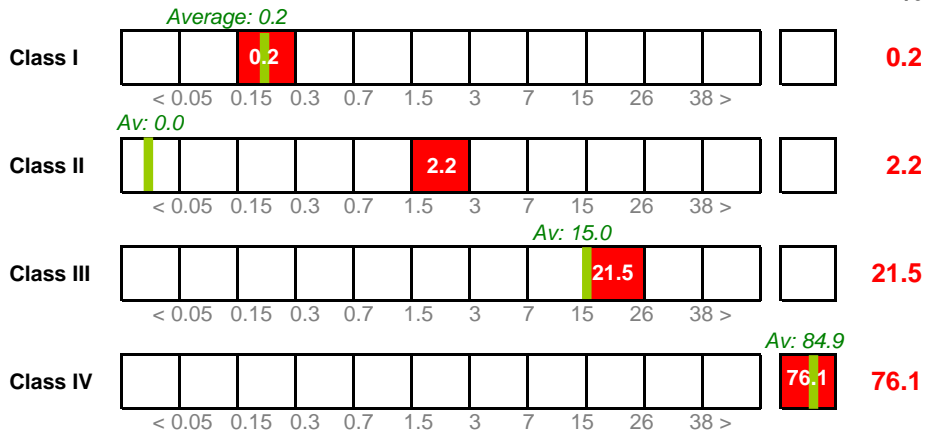

**Justification** As a small child could easily become trapped between the pipes and the bed in the third bedroom, the probability of severe harm is increased.



**RATING SCORES AFTER IMPROVEMENT**

**IMPROVE** Likelihood to 1 in 320 **Outcomes to** 0.2 | 0.0 | 21.5 | 78.3 %

**Justification** Insulating and covering the pipes would reduce the likelihood of a major accident to near the average for the stock.



*Av: Nos* Average likelihood, outcomes and HHSRS score for hazards from hot surfaces and materials by persons aged under 5 years in 1920-45 flats, 1997-99.



# HOT SURFACES ETC

HHSRS VERSION 2

<b>Vulnerable age</b>	Persons aged under 5 years	<b>Multiple locations</b>	Yes	<b>No</b>
<b>Related hazards</b>	Fire risk	<b>Secondary hazards</b>	Yes	<b>No</b>

A) Cooker position



A) kitchen



A) Plan of kitchen

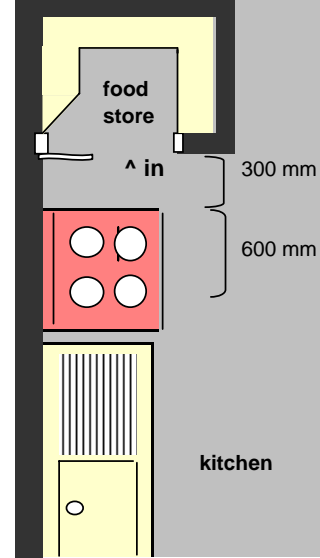

**DESCRIPTION OF HAZARD/S**

**Dwelling:**

1930s, semi-detached house

A) **Cooker position:** The cooker is located between the kitchen sink and the door to a food cupboard leaving only little over a 300 mm gap between the cooker and the open door to enter the cupboard and retrieve food required for cooking. The kitchen floor surface comprises vinyl tiles.

**LIST OF RELEVANT MATTERS**

LIKELIHOOD	A	OUTCOMES	A
a Unprotected hot surfaces	-	a Surface/liquid temperature	3
b Unguarded open flames	2	b Exposure	-
c Hot water to bath	-		
d Hot water to sink	-	<b># Secondary hazards</b>	<b>A</b>
e Thermostatic taps	-	None	-
f Kitchen layout	3		
g Inadequate separation	-	<b>Key</b>	<b>3</b> Seriously defective
h Disrepair	-		<b>2</b> Defective
i Inadequate space	3		<b>1</b> Not satisfactory
			- Satisfactory

## HEALTH AND SAFETY RATING SYSTEM SCORES

1920-45 House

LIKELIHOOD Low → High

1 in 56

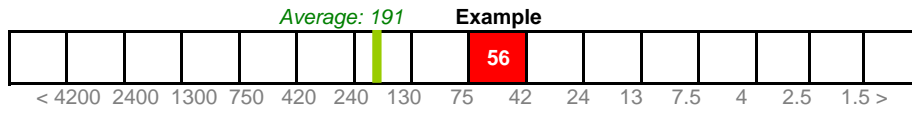

**Justification** Although the cooker is away from the main thorough fare between the kitchen and living room, there is likely to be a need to enter the food cupboard to retrieve ingredients during the process of cooking. Although the risk is generally apparent, the need to squeeze past the cooker to get to the food cupboard is bound to increase significantly the risk of an accident occurring. The lack of a worktop at either side of the cooker will also further increase the likelihood slightly.

### OUTCOMES

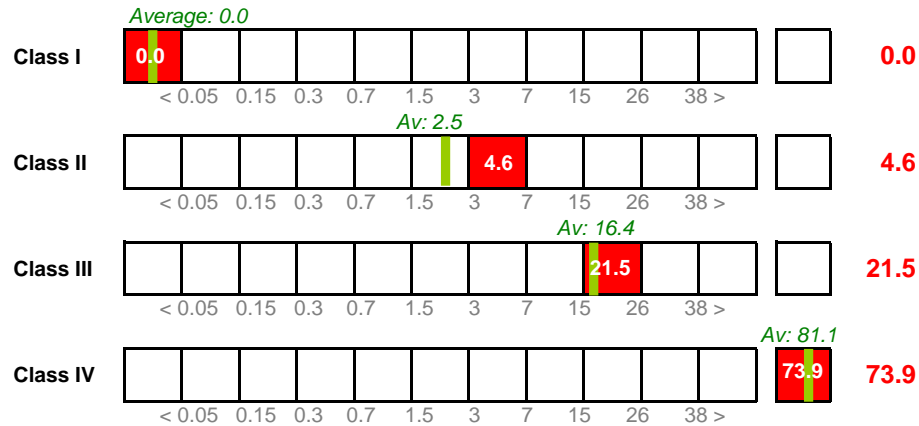

**Justification** As a large proportion of all major burns and scalds occur in the kitchen, the spread of health outcomes in this example will tend towards the average.

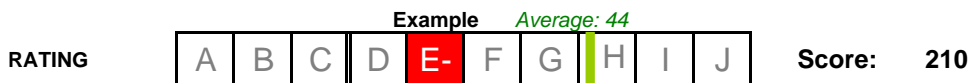

### RATING SCORES AFTER IMPROVEMENT

**IMPROVE** Likelihood to 1 in 180 Outcomes to 0 | 2.2 | 21.5 | 76.3 %

**Justification** This hazard could be largely eliminated by resiting the door to the larder next to the living room door. However, if possible, a better solution would be to resite the cooker in the kitchen, such that that there is a worktop either side of the appliance. This would reduce the likelihood and spread of outcomes for this hazard to near the average for the stock and reduce the rating to Band G-.

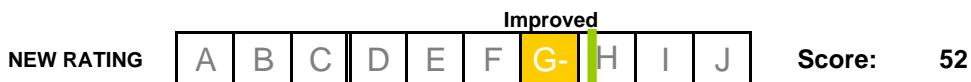

Av: Nos Average likelihood, outcomes and HHSRS score for hazards from hot surfaces and materials by persons aged under 5 years in 1920-45 houses, 1997-99.



# COLLISION HAZARDS (Low Headroom)

HHSRS VERSION 2

<b>Vulnerable age</b>	Persons aged 16 years or over	<b>Multiple locations</b>	Yes	No
<b>Related hazards</b>	None	<b>Secondary hazards</b>	Yes	No

Front elevation



A) Bedroom door



A) Vertical section

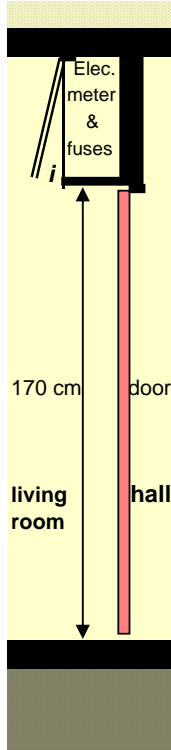

A) Plan

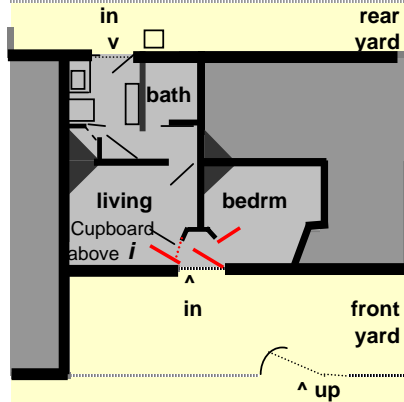

B) Front door



## DESCRIPTION OF HAZARDS

**Dwelling:** c.1880, Mid-terraced, former almshouse

- A) Internal doors:** The internal doors leading from the small hall to the living room on the one side and to the only bedroom on the other both have very low headrooms, the head of the frames being only some 170 cm above the floor. The headroom on the living room door is made worse by a full width cupboard immediately above the door, which projects around 30 cm and houses the electricity meters and fuses. All other internal doors are of more or less normal height.
- B) Front door:** The frame to the front door is only approaching normal height (195 cm) in the very centre of the door, the arches starting from a height of around 135 cm. The rear external kitchen door is of normal height

## LIST OF RELEVANT MATTERS

### LIKELIHOOD & OUTCOMES

<i>a</i>	Door design defects
<i>b</i>	Disrepair to doors
<i>c</i>	Door closer defects
<i>d</i>	Door location
<i>e</i>	Window design defects
<i>f</i>	Disrepair to windows
<i>g</i>	Window location
<i>h</i>	Non-safety glass
<i>i</i>	Unprotected gaps
<i>j</i>	Low headroom to doors
<i>k</i>	Low beams and ceilings

A

-

-

-

-

-

-

-

-

3

-

### # Secondary hazards

None

A

-

### Key

3	Seriously defective
2	Defective
1	Not satisfactory
-	Satisfactory/NA



# COLLISION & ENTRAPMENT

HHSRS VERSION 2

<b>Vulnerable age</b>	Persons aged 5 years or under	<b>Multiple locations</b>	<b>Yes</b>	<b>No</b>
<b>Related hazards</b>	Falls between levels	<b>Secondary hazards</b>	<b>Yes</b>	<b>No</b>

Living room window



Plan through jamb

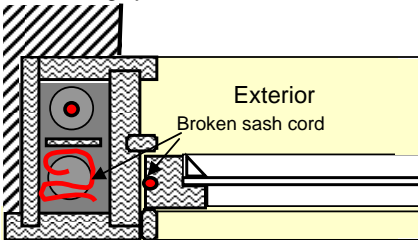

Front elevation



Rear elevation



Original sash windows



## DESCRIPTION OF HAZARD

**Dwelling:**

1910, 3 bedroomed mansion flat

**Background:** This is a five storey late Edwardian mansion block which has balcony access at the rear. The living room of this third floor flat, also located at the rear, still retains its two original vertical sliding box sash windows. Both of these have low sills (under 700 mm high).

- A) Living room windows:-** In each window, the two large sliding sashes comprise a thin frame, each carrying two large panes of single glazing. All the sash cords are threadbare, and in one window, the cord holding one side of the lower opening light has snapped. This window can still be opened and will remain open due to the one remaining counter weight and the friction resulting from the consequent tilting of the frame. In summer, both windows are regularly left open as the living room faces due south and otherwise gets over-heated.

## LIST OF RELEVANT MATTERS

### LIKELIHOOD & OUTCOMES

- a Door design defects
- b Disrepair to doors
- c Door closer defects
- d Door location
- e Window design defects
- f Disrepair to windows
- g Window location
- h Non-safety glass
- i Unprotected gaps
- j Low headroom to doors
- k Low beams and ceilings

**A**

-

-

-

-

-

3

-

-

-

-

-

### # Secondary hazards

None

**A**

-

### Key

- 3 Seriously defective
- 2 Defective
- 1 Not satisfactory
- Satisfactory/NA

## HEALTH AND SAFETY RATING SYSTEM SCORES

Pre 1920 purpose-built Flat

LIKELIHOOD Low → High

1 in 32

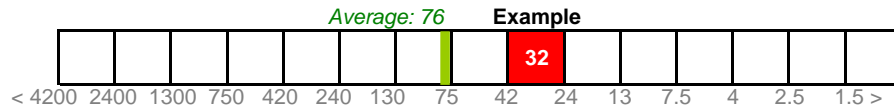

### Justification

The threadbare condition of the sash cords, particularly those of the most frequently opened lower frames, suggests that the remaining cords and particularly that on the sash where there is already a broken cord, could break during the following 12 months. As this is most likely to snap while the window is being opened or closed, the likelihood of harm is increased.

### OUTCOMES

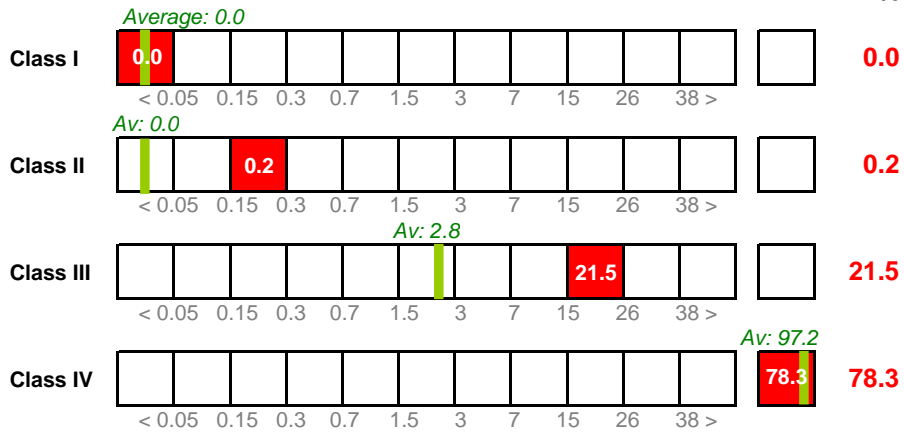

### Justification

The major proportion of collision and entrapment accidents involve trapping limbs or fingers in doors and casement windows. The vertical motion of this sash window and heavy weight due to the large panes of glass and the fact that the latter could shatter if the frame slipped down without the retention of the counter weights, increase the possibility of the health outcomes being more severe than average.

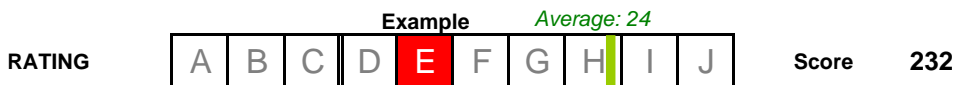

## RATING SCORES AFTER IMPROVEMENT

IMPROVE Likelihood to 1 in 56 Outcomes to 0.0 | 0.1 | 4.6 | 95.3 %

### Justification

Replacing all the sash cords with new sash cord and adjusting and balancing the sash weights would reduce the likelihood towards the average for this hazard. However, other work is advisable to reduce the risk of falls between levels, such as safety catches, guards, or raising the window sills, and perhaps the installation of safety glass.



Av: Nos Average likelihood, outcomes and HHSRS score for collision and entrapment for persons aged 5 years or under in pre 1920 flats, 1997-99.



# EXPLOSIONS

HHSRS VERSION 2

<b>Vulnerable age</b>	All ages	<b>Multiple locations</b>	Yes	<b>No</b>
<b>Related hazards</b>	Uncombusted gas: Carbon Monoxide etc	<b>Secondary hazards</b>	Yes	<b>No</b>

**A) Gas fire to ground floor front room**



Front elevation



Rear elevation



**DESCRIPTION OF HAZARDS**

**Dwelling:** 1920s semi-detached house

**A) Gas pipe and fire:** The gas fire fitted into the open fireplace in the front living room is old and obsolete. The joint between the fire and the opening is unsealed. However, more relevant is that the movement of the gas fire has loosened the joint between the pipe and the gas tap. There is no permanent means of ventilation to the room. Neither the fire nor the gas installations have been checked or serviced over the last five years.

**LIST OF RELEVANT MATTERS**

LIKELIHOOD	A	# Secondary hazards	A
<i>a</i> Unauthorised gas supply	-	- None	-
<i>b</i> Siting of gas tanks	-		
<i>c</i> Gas installations - defects	3		
<i>d</i> Gas appliance - defects	3		
<i>e</i> Maintenance defects	3		
<i>f</i> Ventilation	3		
<i>g</i> Gas storage	-		
<i>h</i> Hot water storage tanks	-		
<i>i</i> Vented hot water system	-	<b>Key</b> 3 Seriously defective	1 Not satisfactory
<i>j</i> Unvented hot water system	-	2 Defective	- Satisfactory/NA

## HEALTH AND SAFETY RATING SYSTEM SCORES

1920-45 house

LIKELIHOOD Low → High

1 in 32

Average: 159,528

Example

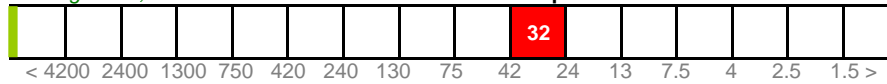

**Justification** Whether or not the fire is in use, there is a significant likelihood of uncombusted gas leaking into the room. With no means of permanent ventilation (particularly at high level) the gas will accumulate within the room. A spark from a light switch or electric socket, or a lighted match would be sufficient to cause an explosion. On the otherhand, it is likely that the smell of gas would alert most people to the problem first and this has been taken into account when determining the likelihood.

### OUTCOMES

%

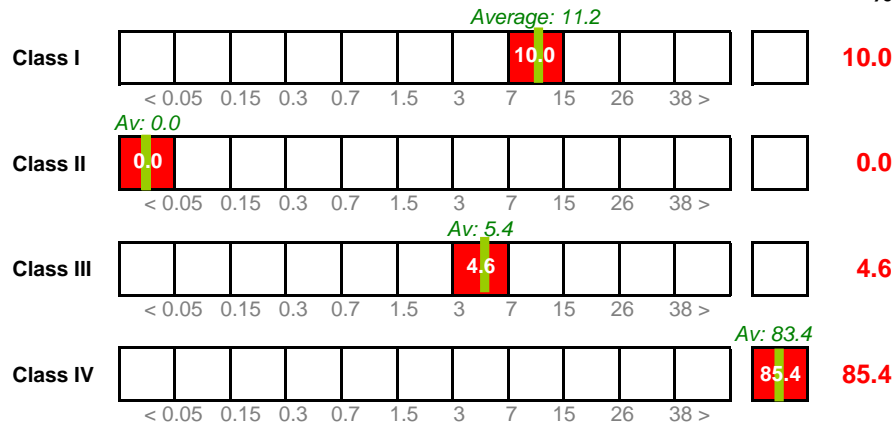

**Justification** There is nothing to suggest that the harm outcomes will differ from the average



### RATING SCORES AFTER IMPROVEMENT

**IMPROVE** Likelihood to 1 in 5,600 Outcomes to 10.0 | 0.0 | 4.6 | 85.4 %

**Justification** The gas installations and this gas fire (and any other gas appliances) should be properly tested and any works carried out. This would probably include renewal of the fire and of the pipe work. In addition, permanent means of ventilation (at high level) should be installed. These works would bring the likelihood to the average.



Av: Nos Average likelihood, outcomes and HHSRS score for hazards from explosions for all persons in 1920-45 houses and all dwellings, 1997-99



# POOR ERGONOMICS

HHSRS VERSION 2

<b>Vulnerable age</b>	Persons aged 60 years or over	<b>Multiple locations</b>	Yes	<b>No</b>
<b>Related hazards</b>	Damp and mould growth, Falls associated with bath	<b>Secondary hazards</b>	Yes	<b>No</b>

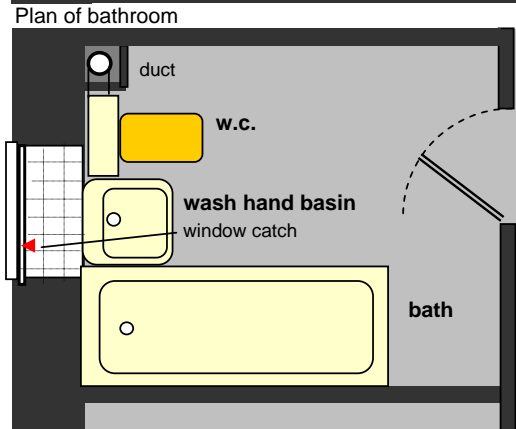
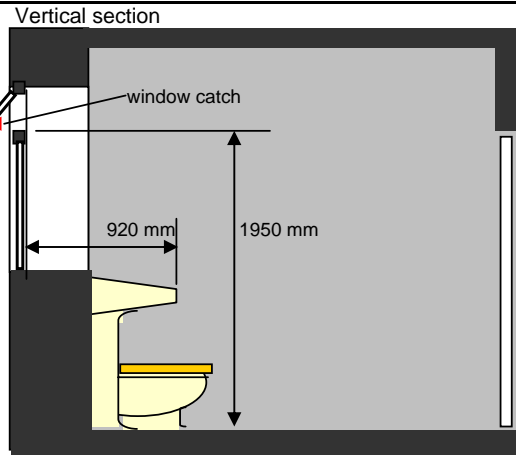

## DESCRIPTION OF HAZARDS

**Dwelling:** 1 bed converted flat in 1890's house

**Background:** A large 3 storey stone built Victorian house has been converted into self-contained flats. The ground floor flat has its bathroom at the rear of the building. The bath, wash hand basin and w.c. are all located, close together, along the external wall, to minimise the pipe runs to a soil pipe in the corner of the room.

**Bathroom window:** The window is set on the external face of the thick rear stone wall, and has an internal tiled sill at the back of the wash hand basin of some 450 mm in depth. The window itself comprises a fixed light with a shallow opening top hung light above, both fitted with obscure glazing. The window catch on the opening light is positioned above the deep tiled sill opposite where the wash hand basin overlaps the bath. The opening light provides the sole means of ventilation for the bathroom, which suffers from mould growth.

## LIST OF RELEVANT MATTERS

LIKELIHOOD & OUTCOMES	A	# Secondary hazards	A
a Position of amenity	3	- None	-
b Space for amenity	-		
c Kitchen worktops	-		
d Kitchen space	-		
e High level storage	-		
f Window controls	3		
g Electric switch/sockets	-		
h Operation of windows etc	2		
		<b>Key</b>	3 Seriously defective
			2 Defective
			1 Not satisfactory
			- Satisfactory/NA

## HEALTH AND SAFETY RATING SYSTEM SCORES

Pre 1920 converted s/c Flat

LIKELIHOOD Low → High

1 in 180

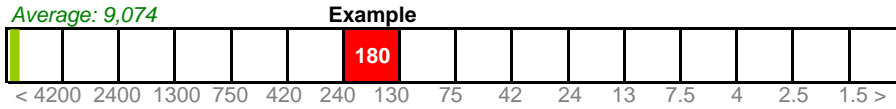

### Justification

The catch to the top opening light is positioned just under 2 metres above the bathroom floor. This height would be just acceptable, except that to reach the catch in this case also entails stretching over both the full sized wash hand basin and the deep window sill, this being a total horizontal distance of some 920 mm. Without standing on or in the bath, this makes the window catch very awkward to reach and the full opening of the top-hung window virtually impossible for anyone of average height or below.

### OUTCOMES

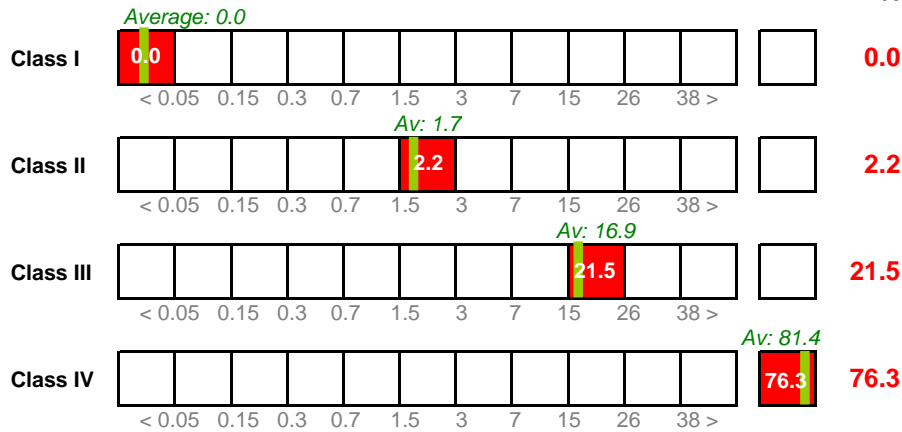

### Justification

Although the likelihood is higher than average, the spread of harms is not changed. In terms of poor ergonomics, therefore, the overall risk would be relatively low, the rating score being 52 or Band G-. In practice, a greater risk from this deficiency is likely to arise from the window being consequently left unopened, not just because of its inaccessibility but for reasons of security. This is likely to lead to a further increases in condensation and mould growth.



## RATING SCORES AFTER IMPROVEMENT

IMPROVE Likelihood to 1 in 5,600 Outcomes to 0.0 | 2.2 | 21.5 | 76.3 %

### Justification

Resiting the wash hand basin on the internal wall, on the opposite side of the soil pipe and duct, would allow easier access to the window. However, ideally the window should also be replaced with one having a larger opening light and lower catch or, alternatively, to improve security, mechanical ventilation should be installed. This would reduce the HHSRS score to average.



Av: Nos Average likelihood, outcomes and HHSRS score for hazards from poor ergonomics for persons aged 60 years or more in pre 1920 flats and all dwellings, 1997-99

# STRUCTURAL COLLAPSE

HHSRS VERSION 2

<b>Vulnerable age</b>	All ages	<b>Multiple locations</b>	Yes	<b>No</b>
<b>Related hazards</b>	Dampness, Personal Hygiene	<b>Secondary hazards</b>	Yes	<b>No</b>

A) Foot of bath



Front elevation

A) Head of bath



A) Floor below bath



## DESCRIPTION OF HAZARDS

**Dwelling:** 1930s semi-detached house

**A) Floor below bath:** The bathroom is on the first floor at the rear of the house above the kitchen. Wet rot in the floor below the bath has caused the boards to rot and some of the end of the floor joists to lose their bearing. The edge of the bath adjacent to the external wall has already dropped by up to 3 cm, resulting in cracks and bulging to the kitchen ceiling below. Immediately below the bath are the kitchen units, which include an electric cooker.

## LIST OF RELEVANT MATTERS

### LIKELIHOOD

<b>a</b>	Structural movement	<b>A</b>	3
<b>b</b>	Structural cracks etc		1
<b>c</b>	Open joints - to brick etc		-
<b>d</b>	Cladding defects		-
<b>e</b>	Loose coping(s)		-
<b>f</b>	Loose guarding		-
<b>g</b>	Structural damage		3
<b>h</b>	Disrepair to lintels/sills		-
<b>i</b>	Insecure frames or hinges		-
<b>j</b>	Roof movement		-
<b>k</b>	Loose roof covering		-
<b>l</b>	Loose pots - to chimneys		-
<b>m</b>	Insecure rainwater goods		-
<b>n</b>	Staircase failure		-
<b>o</b>	Insecure guarding		-
<b>p</b>	Defective ceilings etc		3
	Defective floors		3

<b>q</b>	Defective internal walls	<b>A</b>	-
<b>r</b>	Insecure internal frames		3
<b>s</b>	Loose fittings & fixtures		3





### OUTCOMES

<b>x</b>	Height above ground		1
<b>y</b>	Size/weight of element		3

### # Secondary hazard

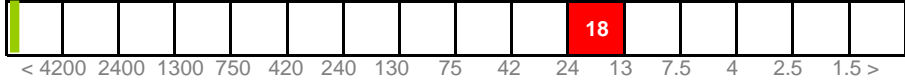
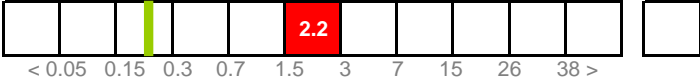
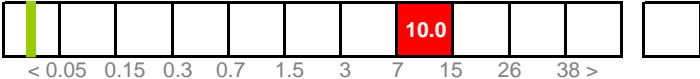
None		-
------	--	---

<b>Key</b>	3	Seriously defective	1	Not satisfactory
	2	Defective	-	Satisfactory/NA

<b>HEALTH AND SAFETY RATING SYSTEM SCORES</b>		<b>1920-45 House</b>
<b>LIKELIHOOD</b> Low → High	<b>1 in 18</b>	
<div style="display: flex; justify-content: space-between; align-items: flex-start;"> <div style="color: green;">Average: 9.010</div> <div style="text-align: center;"> <b>Example</b>   </div> </div>		
<b>Justification</b>	The rot in the floor has been caused by penetrating damp through the walls where the render has failed and is likely get progressively worse. While not immediately unsafe, the weight of a full bath of water and person, particularly if heavy, is likely to lead increasingly to a total collapse of the floor and bath. It is judged there there is a 1 in 18 probability of this occurring over the following 12 months.	
<b>OUTCOMES</b>	<b>%</b>	
Class I <div style="display: flex; justify-content: space-between; align-items: flex-start; margin-top: 5px;"> <div style="color: green;">Average: 0.2</div> <div style="text-align: center;">  </div> <div style="border: 1px solid black; width: 30px; height: 30px; display: flex; align-items: center; justify-content: center; margin-left: 10px;"> <span style="color: red; font-weight: bold;">2.2</span> </div> </div>	<b>2.2</b>	
Class II <div style="display: flex; justify-content: space-between; align-items: flex-start; margin-top: 5px;"> <div style="color: green;">Av: 0.0</div> <div style="text-align: center;">  </div> <div style="border: 1px solid black; width: 30px; height: 30px; display: flex; align-items: center; justify-content: center; margin-left: 10px;"> <span style="color: red; font-weight: bold;">10.0</span> </div> </div>	<b>10.0</b>	
Class III <div style="display: flex; justify-content: space-between; align-items: flex-start; margin-top: 5px;"> <div style="color: green;">Av: 9.6</div> <div style="text-align: center;">  </div> <div style="border: 1px solid black; width: 30px; height: 30px; display: flex; align-items: center; justify-content: center; margin-left: 10px;"> <span style="color: red; font-weight: bold;">31.6</span> </div> </div>	<b>31.6</b>	
Class IV <div style="display: flex; justify-content: space-between; align-items: flex-start; margin-top: 5px;"> <div style="color: green;">Av: 90.2</div> <div style="text-align: center;">  </div> <div style="border: 1px solid black; width: 30px; height: 30px; display: flex; align-items: center; justify-content: center; margin-left: 10px;"> <span style="color: red; font-weight: bold;">56.2</span> </div> </div>	<b>56.2</b>	
<b>Justification</b>	Although the structural collapse is likely to be confined to the bathroom floor and bath, the location of the kitchen, particularly the electric cooker immediately below the bath increases the chance of a fatal, severe or serious outcome occurring, well above the average.	
<b>RATING</b>	<div style="display: flex; justify-content: center; align-items: center;"> <div style="margin-right: 10px;"><b>Example</b></div> <div style="color: green;">Average: 1</div> </div> 	<b>Score 2335</b>
<b>RATING SCORES AFTER IMPROVEMENT</b>		
<b>IMPROVE</b>	Likelihood to <span style="color: red;">1 in 5,600</span> Outcomes to <span style="color: red;">0.2   0.0   10.0</span> <span style="color: red;">89.8 %</span>	
<b>Justification</b>	Fully repairing the bathroom floor and external walls to prevent further penetrating damp would, by solving the only structural problems in the dwelling, reduce the both likelihood of structural collapse and the spread of harms to average.	
<b>NEW RATING</b>	<div style="display: flex; justify-content: center; align-items: center;"> <div style="margin-right: 10px;"><b>Improved</b></div>  </div>	<b>Score 1</b>
Av: Nos    Average likelihood, outcomes and HHSRS score for hazards from structural failure for all persons in 1920-45 houses, 1997-99		

# STRUCTURAL COLLAPSE

HHSRS VERSION 2

<b>Vulnerable age</b>	All ages	<b>Multiple locations</b>	Yes	No
<b>Related hazards</b>	Damp and mould	<b>Secondary hazards</b>	Yes	No

**A) Slipped and missing slates on rear roof**



**B) Dormer to top floor rear room**



**DESCRIPTION OF HAZARD/S**

**Dwelling :** Top dwellings in pre 1920 HMO

**Background:** The house comprises two floors plus a basement and attic and is generally in poor repair. The rear roof, particularly, is affected by 'nail sickness' with many slipped and some missing slates. The rear eavesgutter is loose. Chimney pots also appear unstable. Immediately below the affected roof is a roof terrace for the top floor maisonette being assessed, and one floor below a wide landing to common external stairs leading to the basement level garden. The hazard affects more than one dwelling, but to different degrees.

**LIST OF RELEVANT MATTERS**

LIKELIHOOD		A		A	
a	Structural movement	-	q	Defective floors	-
b	Structural cracks etc	-	r	Defective internal walls	-
c	Open joints - to brick etc	-	s	Insecure internal frames	-
d	Cladding defects	-	t	Loose fittings & fixtures	-
e	Loose coping(s)	-	<b>OUTCOMES</b>		
f	Loose guarding	-	a	Height above ground	2
g	Structural damage	-	b	Size/weight of element	3
h	Disrepair to lintels/sills	-	<b># Secondary hazards</b>		
i	Insecure frames or hinges	-	None		
j	Roof movement	-			
k	Loose roof covering	3	<b>Key</b>		
l	Loose pots - to chimneys	3	3	Seriously defective	1 Not satisfactory
m	Insecure rainwater goods	2	2	Defective	- Satisfactory/NA
n	Staircase failure	-			
o	Insecure guarding	-			
p	Defective ceilings etc	-			

**HEALTH AND SAFETY RATING SYSTEM SCORES**

Pre 1920 Non s/c Flat

LIKELIHOOD Low → High

1 in 56

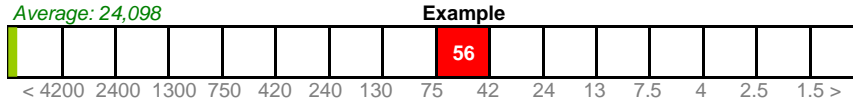

**Justification** The likelihood of a person being struck by a falling element is significantly higher than average. This is due to the location of the roof terrace above the back addition, this being the only outdoor space available to the top floor maisonette, and the presence of the common outdoor landing and stairs providing the main access to the basement level garden. The fear of being struck, limiting the enjoyment of these outdoor spaces, is also a factor increasing the likelihood of health outcomes such as stress as well as of physical injury.

**OUTCOMES**

%

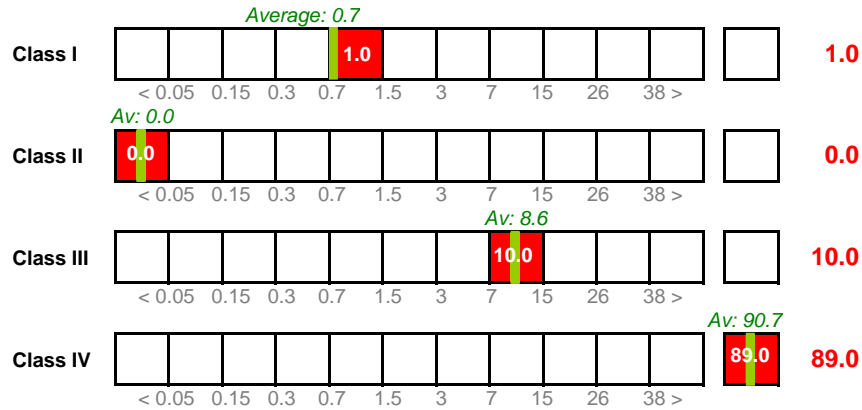

**Justification** The health outcomes are judged to be no higher than average. However, with the high likelihood of 1 in 56, this spread of outcomes gives a score of 248 and a band E rating.

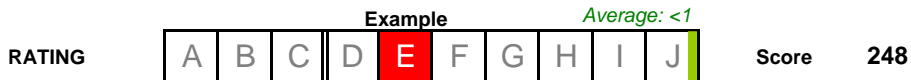

**RATING SCORES AFTER IMPROVEMENT**

**IMPROVE** Likelihood to 1 in 5,600 Outcomes to 1.00 | 0.0 | 10.0 | 89.0 %

**Justification** To reduce this hazard to average, the minimum works would include stripping, felting and re-slating the whole of roof; renewing the rainwater goods; and replacing or removing the chimney pots. However, other works are clearly required to the house as a whole. For the top floor flat, the damp and mould growth - also resulting from the disrepair of this roof - represents the most serious hazard, as shown by the previous worked example (WE 01.2 V2).



Av: Nos Average likelihood, outcomes and HHSRS score for hazards from structural failure for all persons in pre 1920 flats, 1997-99